

Grove RT890E

Product Guide



Features

- 80 t (90 USt) capacity
- 11,4 m – 43,2 m (38 ft – 142 ft) five-section, full power boom
- 10 m – 17 m (33 ft – 56 ft) offsettable bi-fold lattice, swingaway extension
- 4,8 m (16 ft) or 9,7 m (32 ft) extension inserts
- Grove MEGAFORM™ boom
- 9979 kg (22,000 lb) counterweight hydraulically installed and removed



Features

Removable counterweight

Counterweight and auxiliary hoist is hydraulically removed/installed for easier hauling from job to job.



CraneSTAR

CraneSTAR is an exclusive and innovative crane asset management system that helps improve your profitability and reduce costs by remotely monitoring critical crane data. Visit www.cranestar.com for more information.



Power luffing extension

For improved up-and-over reach, a power luffing extension is available on the RT890E and hydraulically offsets from the super-structure cab from 5° to 40°.



Boom

The RT890E is equipped with a 11,4 m - 43,2 m (38 ft - 142 ft) five-section, full power boom. The Grove MEGAFORM™ boom shape eliminates weight and increases capacity compared to conventional shapes.



Cab

The Full Vision cab on the RT890E tilts up to 20° providing the operator additional comfort when working at long boom and extension lengths.

Contents

Features	2
Specifications	4
Dimensions and weights	7
Working range	8
Mode A vs. (Mode B)	9
Load chart (Mode B)	10
Load chart fixed offsettable swingaway	11
Working range with one 16 ft insert	12
Working range with two 16 ft inserts	13
Load charts fixed offsettable swingaway with inserts	14
Load charts (Mode A)	15
Luffing extension charts	17
Load handling	21

Specifications

Superstructure



Boom

11,4 m – 43,2 m (38 ft – 142 ft) five-section, sequenced synchronized full power boom with A and B mode.

Maximum tip height: 45,7 m (150 ft).



*Optional lattice extension

10 m – 17 m (33 ft – 56 ft) offsettable bi-fold lattice swingaway extension. Offsets 0°, 20° and 40°. Stows alongside base boom section.

Maximum tip height: 62,7 m (206 ft).



*Optional lattice extension

10 m – 17 m (33 ft – 56 ft) hydraulically offsettable bi-fold lattice swingaway extension. Offsets from 0° to 40°. Stows alongside base boom section.

Maximum tip height: 62,7 m (206 ft).



*Optional lattice extension inserts

(2) x 4,8 m (16 ft) lattice extension inserts. Installs between the boom nose and bi-fold extension, non-stowable.

Maximum tip height: 72,5 m (238 ft)



Boom nose

Five nylatron sheaves mounted on heavy duty tapered roller bearings with removable pin-type rope guards. Quick reeving type boom nose. Removable auxiliary boom nose with removable pin type rope guard.



Boom elevation

One double acting hydraulic cylinder with integral holding valve provides elevation from -3° to +78°.



Load moment and anti-two block system

Standard “Graphic Display” load moment and anti-two block system with audio-visual warning and control lever lockout. These systems provide electronic display of boom angle, length, radius, tip height, relative load moment, maximum permissible load, load indication and warning of impending two-block condition. The standard Work Area Definition System allows the operator to pre-select and define safe working areas. If the crane approaches the pre-set limits, audio-visual warnings aid the operator in avoiding job-site obstructions.



Cab

20° tilt, Full-vision, all-steel fabricated with acoustical lining and tinted safety glass throughout. Deluxe seat incorporates armrest-mounted hydraulic single-axis controllers. Tilt/telescoping steering wheel with various controls incorporated into the steering column. Other standard features include: hot water heater, cab circulating air fan, sliding side and rear windows, sliding skylight with electric wiper and sunscreen, electric windshield wash/wipe, fire extinguisher, seat belt, air conditioning, and dual cab mounted work lights.



Swing

Two speed, planetary swing drive with foot applied multi-disc wet brake. Spring applied, hydraulically released swing brake. Single position mechanical house lock, operated from cab. Maximum speed: 2.0 rpm.



Counterweight

9979 kg (22,000 lb). Hydraulically installed and removed.

Specifications

Superstructure (continued)



Hoist specifications (HP30-18G) main and auxiliary hoist

Planetary reduction with automatic spring applied multi-disc wet brake. Electronic hoist drum rotation indicators, and hoist drum cable followers.

Maximum single line pull:

1st layer: 9185 kg (20,250 lb)

3rd layer: 7715 kg (17,010 lb)

5th layer: 6650 kg (14,660 lb)

Maximum permissible line pull:

7620 kg (16,800 lb) with 35x7 class rope

Maximum single line speed: 156 m/min (514 fpm)

Rope construction:

35x7 rotation resistant

Rope diameter: 19 mm (3/4 in)

Rope length:

Main hoist: 182 m (600 ft)

Auxiliary hoist: 182 m (600 ft)

Maximum rope stowage: 256 m (841 ft)

Carrier



Chassis

Box section frame fabricated from high-strength, low alloy steel. Front/rear towing and tie down lugs.



Outrigger system

Four hydraulic telescoping single-stage double box beam outriggers with inverted jacks and integral holding valves. Three position setting, 0%, 50% and fully extended. Outrigger monitoring comes standard.

All steel fabricated, quick release type outrigger floats, 775 mm (30.5 in) diameter.

Maximum outrigger pad load: 56 700 kg (125,000 lb).



Hydraulic system

Two main pumps ([1] piston and [1] gear) with a combined capacity of 503 LPM (133 GPM).

Maximum operating pressure: 277.7 bar (4000 psi).

Three section pressure compensated valve bank. Return line type filter with full flow by-pass protection and service indicator. Replaceable cartridge with micron filtration rating of 5/12/16. 959 L (253

gallon) hyd. reservoir. Carrier mounted oil cooler with thermostatically controlled hydraulic motor driven fan/air to oil. System pressure test ports.



Outrigger controls

Controls and crane level indicator located in cab.



Engine (Tier IVF)

Cummins QSB 6.7L diesel, six-cylinder, turbo-charged. 205 kW (275 hp) at 2500 rpm.

Meets emissions per U.S. E.P.A., Tier IV Final and E.U. Stage IV.

Maximum torque: 987 Nm (728 ft/lb) at 1500 rpm.

Fuel requirement: Minimum of 15 ppm sulphur content (Ultra Low Sulphur Diesel Fuel and Diesel Exhaust Fluid (DEF))

Note: Tier IVF engine required in North American, Canadian, and European Union countries.



Engine (Tier III)

Cummins QSB 6.7 L diesel, six cylinders, turbo-charged, 205 kW (275 bhp) (Gross) at 2500 rpm.

Maximum torque: 987 Nm (728 ft/lb) at 1500 rpm.

Note: Required for sale outside of North American and European Union countries.



Fuel tank capacity

280 L (74 gal)



Transmission

Full rangeshift with 6 forward and 6 reverse speeds.

Front axle disconnect for 4 x 2 travel.



Electrical system

Three 12 V - maintenance free batteries.

12 V starting and lighting. Battery disconnect. CanBus Diagnostic system.

Specifications

Carrier (continued)

Drive

4 x 4.



Steering

Fully independent power steering:

Front: Full hydraulic steering wheel controlled.

Rear: Full hydraulic switch controlled.

Provides infinite variations of 4 main steering modes: front only, rear only, crab and coordinated.

Rear steer indicator.

Turning radius: 7,3 m (24 ft)



Axles

Front: Drive/steer with differential and planetary reduction hubs rigid mounted to frame.

Rear: Drive/steer with differential and planetary reduction hubs pivot mounted to frame.



Oscillation lockouts

Automatic full hydraulic lockouts on rear axle permits 25,4 cm (10 in) oscillation only with boom centered over the front.



Brakes

Full hydraulic split circuit operating on all wheels.

Spring-applied, hydraulically released parking brake mounted on front axle.



Tires

Standard 29.5 x 25 - 34 bias ply, Titan



Lights

Full lighting including turn indicators, head, tail, brake and hazard warning lights.



Maximum speed

35 km/h (22 mph)



Gradeability (theoretical)

75%

(Based on 52 607 kg [115,976 lb] GVW, 29.5 x 25 tires, 43,2 m [142 ft] boom, plus 17,0 m [56 ft] swingaway, 22,000 lb counterweight, 80 t [90 USt] hookblock and 9,1 t [10 USt] headache ball).

Miscellaneous standard equipment

Full width steel fenders, full length aluminum decking, dual rear view mirrors, hook-block tie down, electronic back-up alarm, light package, front stowage well, cab air conditioning, tachometer/hourmeter, rear wheel position indicator, 36,000 BTU hot water cab heater, hoist mirrors, engine distress A/V warning system, front/rear tie down and tow lugs, coolant sight level indicator, CraneSTAR asset management system.

*Optional equipment

- **Auxiliary Lighting and Convenience Package:** includes cab mounted amber flashing light, dual base boom mounted floodlights. LMI light bar (in cab), and rubber mat for stowage trough
- 360° NYC style mechanical swing lock
- Rear Pintle hook
- Cab controlled cross axle differential locks, (front and rear)
- PAT event recorder
- 3rd wrap indicator for main and/or auxiliary hoists
- Wind speed indicator (wireless).
- C.E. Mark Conformance
- Value Package: Includes 33 ft - 56 ft manual bi-fold swingaway, 360° swing lock, and auxiliary hoist package
- 29°C/-20°F Cold Weather Package
- 40°C/-40°F Arctic Weather Package
- Spare Tire and Wheel

Dimensions and weights

Tires	A	B	C	D	E	F	G	A	B	C	D	E	F	G
29.5 X 25	15,7 m (51.5)	16,3 m (5.35)	13,6 m (44.6)	12,9 m (42.3)	12,5 m (41.0)	10,1 m (33.1)	8,8 m (28.9)	11,1 m (36.4)	11,6 m (38.1)	8,4 m (27.6)	7,8 m (25.6)	7,3 m (24.0)	4,9 m (16.1)	4,1 m (13.5)
2 wheel steer								4 wheel steer						

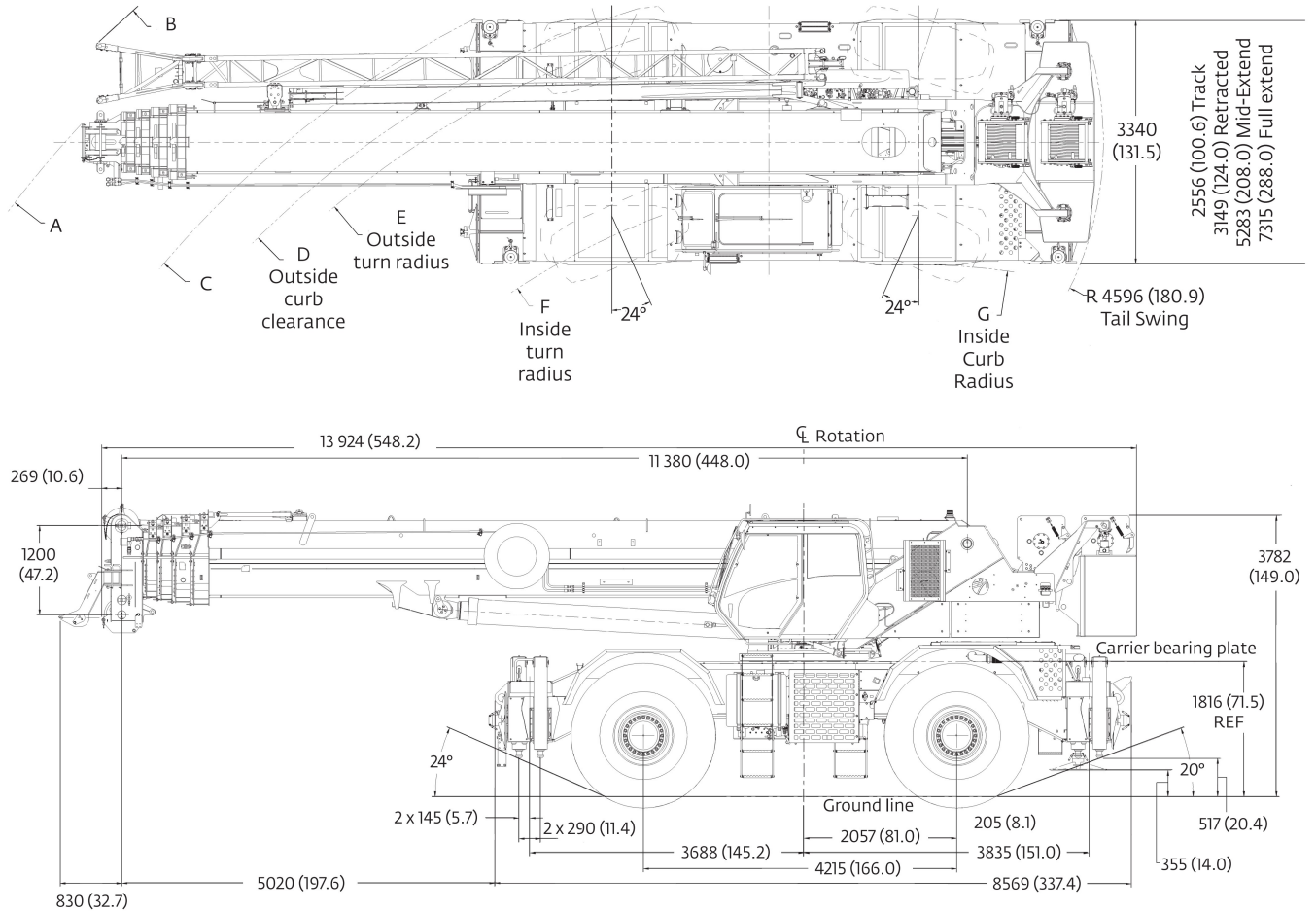

Dimensions are in mm (inches)

Weights	G.V.W. kg (lb)	Front kg (lb)	Rear kg (lb)
Basic Machine including 43,3 m (142 ft) main boom, main and aux. hoist with 182,8 m (600 ft) of rope, manual offsettable bifold swingaway, full counterweight, 9,1 t (10 Ust) headache ball, and 80 t (90 USt) hookblock:	53 178 (117,235)	25 915 (57,131)	27 263 (60,104)
Substitute: Hydraulic offsettable bifold swing-away	53 496 (117,937)	26 394 (58,187)	27 103 (59,750)
Remove: Counterweight and aux. hoist (manual offsettable S/A)	43 250 (95,348)	30 657 (67,587)	12 592 (27,761)
Remove: Counterweight and aux. hoist Hyd. offsettable S/A)	43 407 (95,695)	30 930 (68,188)	12 477 (27,507)
Remove: Counterweight, aux. hoist, and either extension	42 227 (93,094)	27 696 (64,058)	13 171 (29,036)

Working range

141.7 ft main boom 32 ft – 56 ft fixed offset swingaway

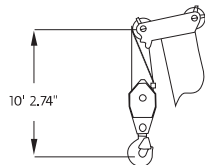
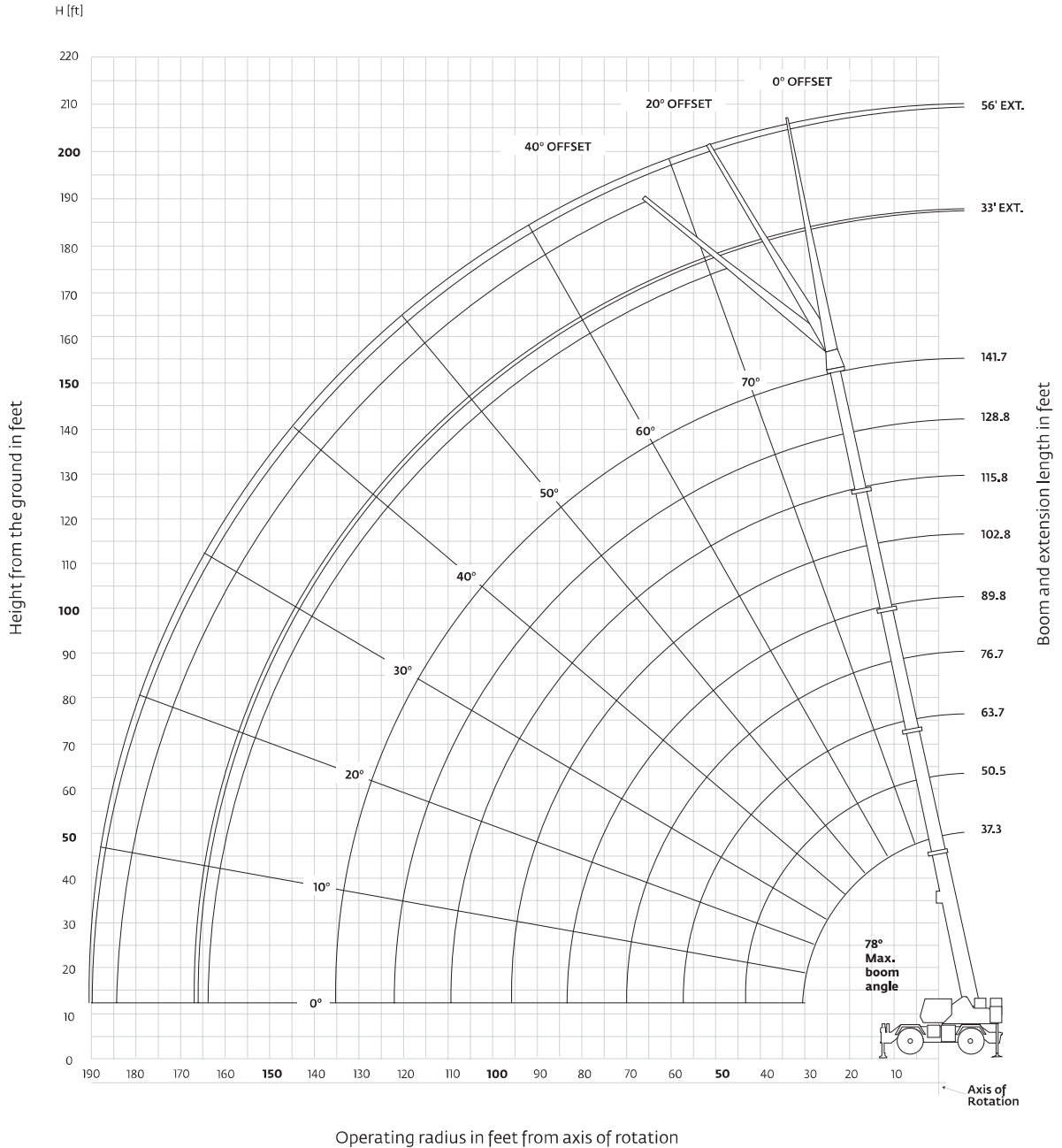

Dimensions are for largest Grove furnished hook block and headache ball, with anti-two block activated.

Mode A vs. Mode B

Mode A – inner-mid retracted								
	Main boom length in feet							
	37.3	50.4	63.4	76.4	89.4	102.4	115.4	141.7
Boom sections:	Percent extension							
Inner-mid	0	0	0	0	0	0	0	100
Center-mid	0	50	100	100	100	100	100	100
Outer-mid	0	0	0	25	50	75	100	100
Fly	0	0	0	25	50	75	100	100

Mode B – normal mode									
	Main boom length in feet								
	37.3	50.5	63.7	76.7	89.8	102.8	115.8	128.8	141.7
Boom sections:	Percent extension								
Inner-mid	0	50	75	75	100	100	100	100	100
Center-mid	0	0	25	75	100	100	100	100	100
Outer-mid	0	0	0	0	0	25	50	75	100
Fly	0	0	0	0	0	25	50	75	100

THIS CHART IS ONLY A GUIDE AND SHOULD NOT BE USED TO OPERATE THE CRANE.

The individual crane's load chart, operating instructions and other instructional plates must be read and understood prior to operating the crane.

Load charts (Mode B)





37.3 ft – 141.7 ft 22,000 lb 100% 360°
 24 ft spread

Feet	Pounds								
	Main boom length in feet								
	37.3	50.5	63.7	76.7	89.8	102.8	115.8	128.8	141.7
10	180,000 (68.5)	134,000 (75)	*97,500 (78)						
12	156,000 (65)	134,000 (72.5)	97,500 (76.5)						
15	128,500 (59.5)	127,500 (69)	97,500 (74)	69,950 (77)	*46,600 (78)				
20	98,650 (49.5)	97,600 (62.5)	86,200 (69)	63,600 (73)	46,600 (76.5)	*38,700 (78)			
25	78,800 (36.5)	77,800 (55.5)	74,850 (64)	55,100 (69)	41,950 (73)	38,700 (75.5)	*37,900 (78)	*30,850 (78)	
30	51,550 (12.5)	58,700 (47.5)	59,300 (58.5)	48,150 (65)	37,350 (69.5)	37,900 (72.5)	35,000 (75)	30,850 (77.5)	*24,400 (78)
35		43,250 (38.5)	43,200 (52.5)	42,450 (60.5)	33,300 (66)	33,200 (69.5)	30,950 (72.5)	28,900 (75)	24,400 (77)
40		33,250 (26)	32,850 (46.5)	33,050 (56)	29,850 (62.5)	29,300 (66.5)	27,450 (70)	25,850 (72.5)	24,250 (75)
45			25,650 (39)	26,000 (51)	25,900 (58.5)	25,950 (63.5)	24,450 (67)	23,150 (70)	21,900 (73)
50			20,350 (30.5)	20,750 (45.5)	20,550 (54.5)	21,950 (60)	21,800 (64.5)	20,750 (67.5)	19,800 (70.5)
55			16,200 (16.5)	16,800 (39.5)	16,450 (50)	17,800 (56.5)	19,150 (61.5)	18,650 (65)	17,900 (68.5)
60				13,600 (33)	13,200 (45.5)	14,550 (53)	15,900 (58.5)	16,800 (62.5)	16,150 (66)
65				11,000 (23.5)	10,600 (40.5)	11,900 (49)	13,250 (55.5)	14,200 (60)	14,650 (64)
70					8420 (34.5)	9750 (45)	11,050 (52)	11,950 (57)	12,850 (61.5)
75					6570 (28)	7910 (40.5)	9250 (48.5)	10,100 (54.5)	10,950 (59)
80					4960 (18)	6340 (36)	7670 (45)	8530 (51.5)	9380 (56.5)
85						4990 (30)	6320 (41)	7150 (48.5)	7980 (54)
90						3780 (23)	5140 (37)	5950 (45)	6770 (51)
95						2710 (10)	4100 (32)	4900 (41.5)	5700 (48.5)
100							3160 (26)	3960 (37.5)	4750 (45.5)
105							2310 (18.5)	3130 (33.5)	3910 (42)
110								2370 (28.5)	3150 (38.5)
115								1680 (22.5)	2460 (35)
120								1050 (13)	1840 (30.5)
125									1250 (25.5)

Minimum boom angle (deg) for indicated length (no load) 0 24
 Maximum boom length (ft) at 0 deg boom angle (no load) 128.8
 #LMI operating code. Refer to LMI manual for instructions.
 *This capacity is based upon maximum obtainable boom angle.
 Note: () Boom angles are in degrees.

Lifting capacities at zero degree boom angle									
Boom angle	Main boom length in feet								
	37.3	50.5	63.7	76.7	89.8	102.8	115.8		
0°	27,500 (30.1)	15,950 (43.3)	9560 (56.4)	5840 (69.5)	2730 (82.6)	1910 (95.6)	1200 (108.5)		

Note: () Reference radii in feet. AG-829-103321A

Load charts

Bi-fold swingaway (fixed offsettable angles)



Pounds						
Feet	33 ft LENGTH			56 ft LENGTH		
	0° OFFSET	20° OFFSET	40° OFFSET	0° OFFSET	20° OFFSET	40° OFFSET
	#0021	#0022	#0023	#0041	#0042	#0043
40	13,700 (78)					
45	13,700 (76.5)	*13,000 (78)		7160 (78)		
50	13,700 (75)	12,950 (77.5)		7160 (77.5)		
55	13,700 (73)	12,600 (76)	*10,250 (78)	7160 (76)		
60	13,700 (71.5)	12,200 (74)	10,050 (77)	7160 (74.5)	*6400 (78)	
65	13,700 (69.5)	11,900 (72.5)	9900 (75)	7160 (73)	6250 (77.5)	
70	13,500 (68)	11,550 (70.5)	9750 (73)	7160 (71.5)	6110 (76)	
75	12,400 (66)	11,250 (68.5)	9610 (71)	7160 (70)	5980 (74.5)	*5110 (78)
80	10,800 (64)	11,000 (67)	9480 (69)	7160 (68.5)	5850 (73)	5020 (77)
85	9330 (62)	10,250 (65)	9370 (67)	7150 (66.5)	5730 (71.5)	4930 (75)
90	8050 (60)	8900 (63)	8980 (65)	6960 (65)	5620 (69.5)	4850 (73.5)
95	6920 (58)	7700 (61)	8530 (63)	6770 (63.5)	5510 (68)	4780 (71.5)
100	5920 (56)	6630 (59)	7360 (61)	6590 (61.5)	5410 (66)	4710 (69.5)
105	5030 (54)	5690 (56.5)	6310 (58.5)	6030 (60)	5310 (64.5)	4650 (68)
110	4230 (52)	4830 (54.5)	5370 (56.5)	5200 (58)	5220 (62.5)	4600 (66)
115	3510 (49.5)	4060 (52)	4520 (54)	4450 (56.5)	5110 (60.5)	4550 (64)
120	2850 (47.5)	3360 (50)	3750 (51.5)	3770 (54.5)	4780 (59)	4500 (62)
125	2250 (45)	2730 (47.5)	3040 (49)	3150 (52.5)	4080 (57)	4460 (60)
130	1700 (42)	2150 (44.5)	2400 (46)	2580 (50.5)	3450 (55)	3970 (58)
135	1200 (39.5)	1610 (42)		2060 (48.5)	2870 (53)	3330 (55.5)
140		1120 (39)		1570 (46.5)	2330 (50.5)	2730 (53)
145				1130 (44)	1830 (48.5)	2180 (50.5)
150					1370 (46)	1670 (48)
155						1200 (45)
Minimum boom angle (°) for indicated length (no load)	38	38	40	43	44	44
Maximum boom length (ft) at 0° boom angle (no load)		102.8			89.8	

NOTE: () Boom angles are in degrees. A6-829-103447
 #LMI operating code. Refer to LMI manual for operating instructions.
 *This capacity is based upon maximum boom angle.

- NOTES:**
- All capacities above the bold line are based on structural strength of boom extension and do not exceed 85% of tipping loads, in accordance with SAE J-765.
 - The 33 ft extension length may be used with single or double part line lifting service. The 56 ft extension length may be used for single line lifting service only.
 - For main boom lengths less than 141.7 ft with the boom extension erected, the rated loads are determined by boom angle. Use only the column which corresponds to the boom extension length and offset for which the machine is set up. For boom angles not shown, use rating of the next lower boom angle.
 - WARNING:** Operation of this machine with heavier loads than the capacities listed is strictly prohibited. Machine tipping with boom extension occurs rapidly and without advance warning.
 - Boom angle is the angle above or below horizontal of the longitudinal axis of the boom base section after lifting rated load.
 - Capacities listed are with outriggers properly extended and vertical jacks set only.
 - When lifting over the main boom nose with 33 ft or 56 ft extension erected, the outriggers must be fully extended or 50% extended (17.3 ft spread).

Working range

141.7 ft main boom and one 16 ft insert

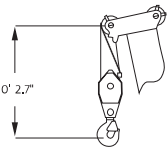
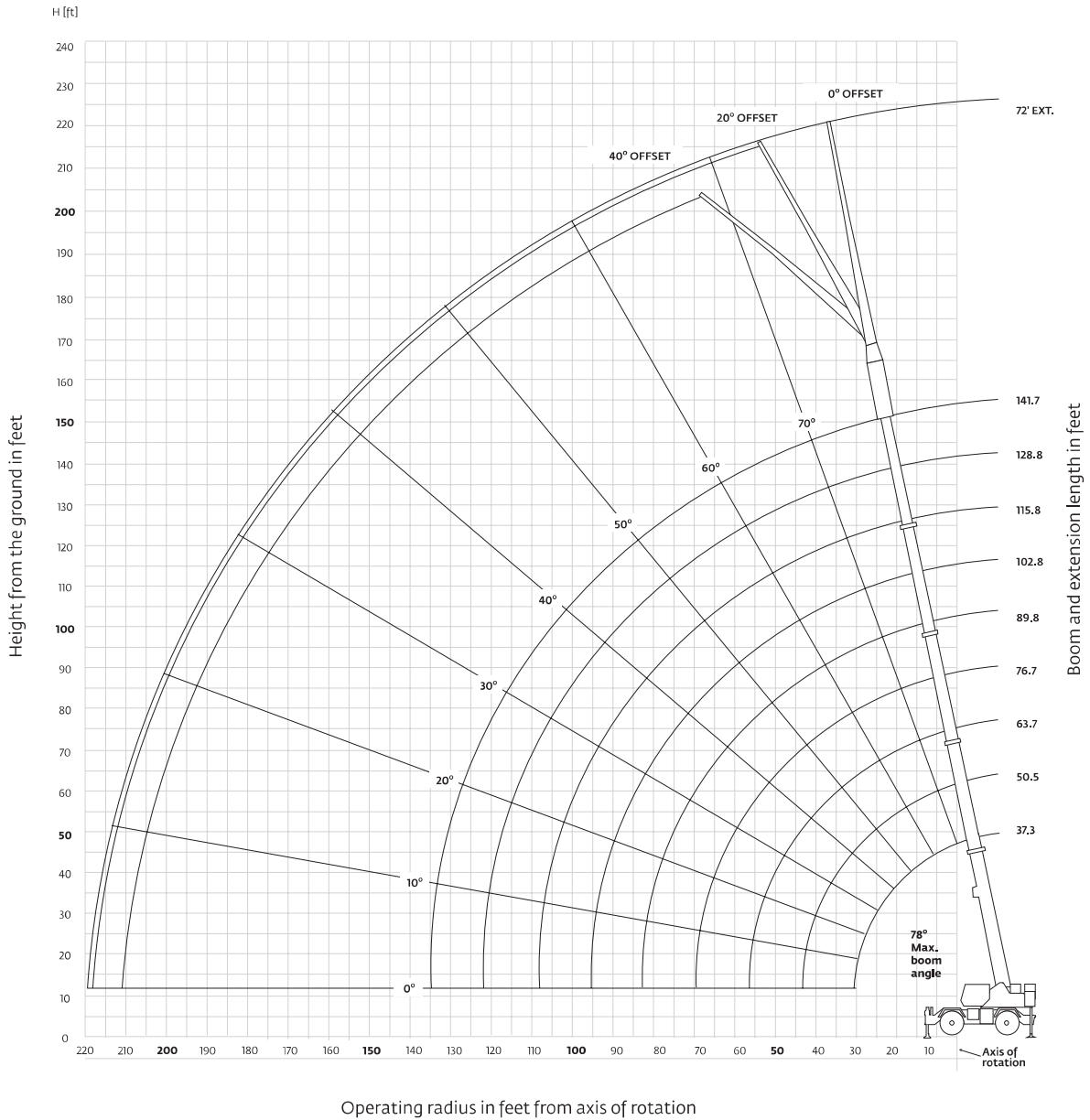

Dimensions are for largest Grove furnished hook block and headache ball, with anti-two block activated.

THIS CHART IS ONLY A GUIDE AND SHOULD NOT BE USED TO OPERATE THE CRANE.

The individual crane's load chart, operating instructions and other instructional plates must be read and understood prior to operating the crane.

Working range

141.7 ft main boom and two 16 ft inserts

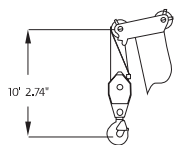
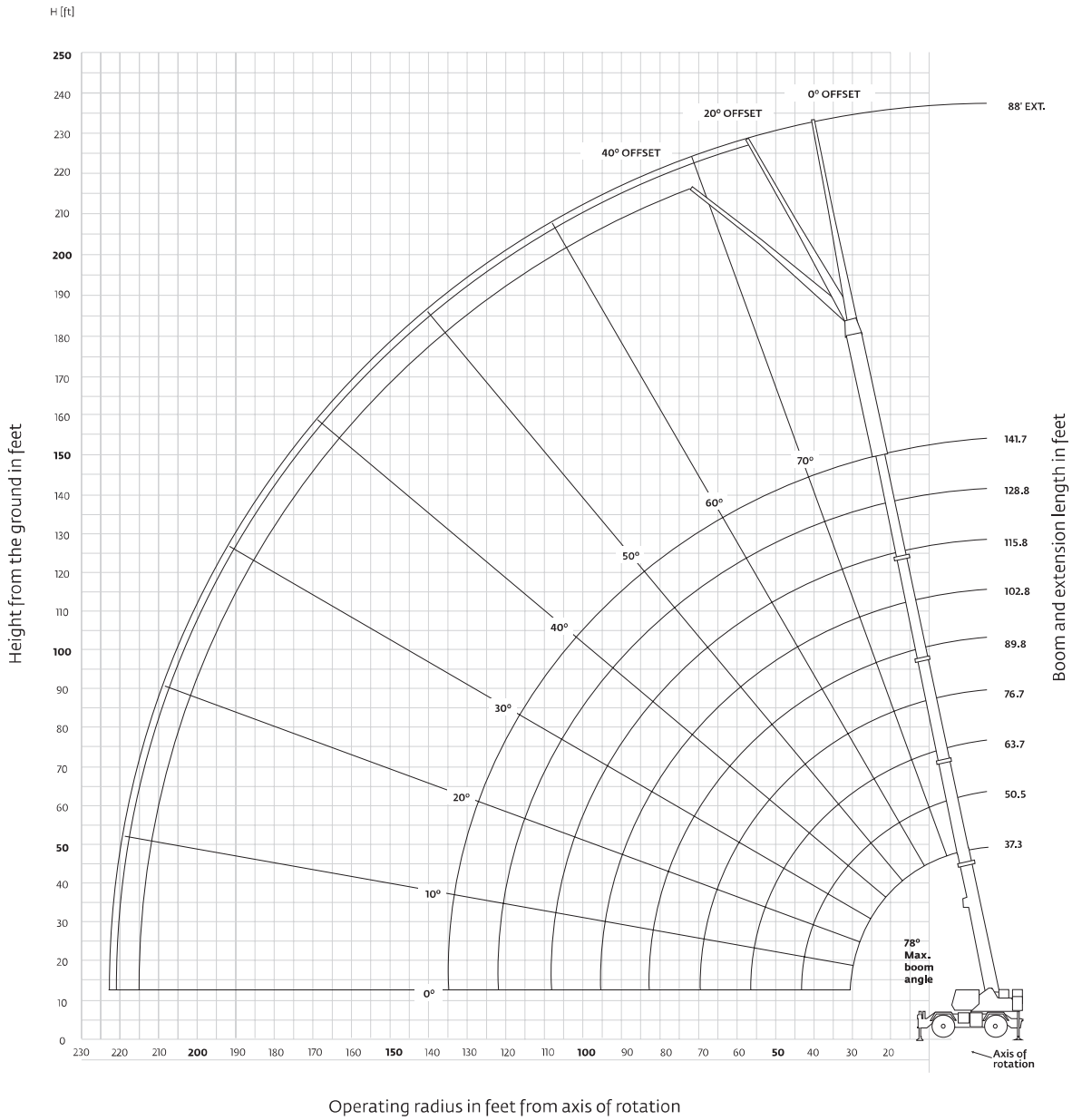







Dimensions are for largest Grove furnished hook block and headache ball, with anti-two block activated.

THIS CHART IS ONLY A GUIDE AND SHOULD NOT BE USED TO OPERATE THE CRANE.

The individual crane's load chart, operating instructions and other instructional plates must be read and understood prior to operating the crane.

Load charts

Bi-fold swingaway with inserts (fixed angles)

 37.3 ft – 141.7 ft
  33 ft – 56 ft
  1 or 2 16 ft inserts
  22,000 lb
  100%
  360°
 24 ft spread

Pounds						
Feet	72 ft (56 ft LENGTH + 1 INSERT)			88 ft (56 ft LENGTH + 2 INSERTS)		
	0°	20°	40°	0°	20°	40°
	OFFSET #0064	OFFSET #0065	OFFSET #0066	OFFSET #0084	OFFSET #0085	OFFSET #0086
50	6300 (78)					
55	6300 (77.5)					
60	6300 (76.5)			5000 (78)		
65	6300 (75)			5000 (77.5)		
70	6300 (73.5)	*6100 (78)		5000 (76)		
75	6,00 (72)	5860 (77.5)		5000 (74.5)	*4900 (78)	
80	6300 (70.5)	5750 (76)	*5000 (78)	5000 (73.5)	4900 (77.5)	
85	6300 (69)	5650 (74.5)	4890 (77.5)	5000 (72)	4900 (76)	
90	6300 (67.5)	5550 (73)	4820 (76)	4900 (70.5)	4900 (74.5)	*4800 (78)
95	6300 (66)	5450 (71.5)	4760 (74.5)	4850 (69.5)	4900 (73.5)	4640 (76.5)
100	6300 (64.5)	5360 (70)	4690 (73)	4800 (68)	4710 (72)	4370 (75)
105	5810 (63)	5120 (68)	4580 (71.5)	4670 (66.5)	4420 (70.5)	4120 (73.5)
110	5030 (61.5)	4880 (66.5)	4480 (69.5)	4550 (65)	4130 (69)	3870 (72)
115	4320 (59.5)	4620 (65)	4270 (68)	4240 (63.5)	3880 (67.5)	3650 (70.5)
120	3680 (58)	4370 (63.5)	4060 (66)	3850 (62)	3630 (66)	3440 (69)
125	3100 (56.5)	4110 (61.5)	3870 (64.5)	3260 (60.5)	3410 (64.5)	3240 (67.5)
130	2560 (54.5)	3500 (60)	3680 (62.5)	2720 (59)	3190 (63)	3050 (65.5)
135	2070 (53)	2940 (58)	3510 (60.5)	2220 (57.5)	3000 (61.5)	2880 (64)
140	1610 (51)	2420 (56)	2980 (58.5)	1760 (56)	2630 (60)	2710 (62.5)
145	1190 (49)	1950 (54.5)	2440 (56.5)	1340 (54.5)	2,150 (58)	2560 (60.5)
150		1500 (52.5)	1930 (54.5)		1700 (56.5)	2210 (58.5)
155		1090 (50.5)	1470 (52)		1290 (54.5)	1750 (57)
160			1030 (50)			1310 (55)
Minimum boom angle (°) for indicated length (no load)	48	49	49	52		53
Maximum boom length (ft) at 0° boom angle (no load)		76.7			76.7	

NOTE: () Boom angles are in degrees. A6-829-103478

#LMI operating code. Refer to LMI manual for operating instructions.

*This capacity is based upon maximum boom angle.

NOTES:

1. All capacities above the bold line are based on structural strength of boom extension and do not exceed 85% of tipping loads, in accordance with SAE J-765.
2. The 56 ft extension length may be used for single line lifting service only.
3. For main boom lengths less than 141.7 ft with the boom extension erected, the rated loads are determined by boom angle. Use only the column which corresponds to the boom extension length and offset for which the machine is set up. For boom angles not shown, use rating of the next lower boom angle.
4. **WARNING:** Operation of this machine with heavier loads than the capacities listed is strictly prohibited. Machine tipping with boom extension occurs rapidly and without advance warning.
5. Boom angle is the angle above or below horizontal of the longitudinal axis of the boom base section after lifting rated load.
6. When lifting over the main boom nose with 56 ft extension erected and inserts, the outriggers must be fully extended and vertical jacks set.

Load charts

(Mode A)





37.3 ft = 141.7 ft **22,000 lb** **100%** **360°**
24 ft spread

Feet	Pounds							
	37.3	50.4	63.4	76.4	89.4	102.4	115.4	141.7
10	180,000 (68.5)	134,000 (75)	*80,800 (78)					
12	156,000 (65)	134,000 (72.5)	80,800 (76.5)	*38,700 (78)				
15	128,500 (59.5)	129,000 (68.5)	80,800 (73.5)	38,700 (77)	*38,500 (78)			
20	98,650 (49.5)	98,950 (62)	70,950 (68.5)	38,700 (73)	38,500 (76.5)	*38,400 (78)		
25	78,800 (36.5)	79,150 (55)	62,300 (63.5)	38,700 (69)	38,500 (73)	38,400 (76)	24,400 (78)	
30	51,550 (12.5)	60,500 (47)	55,250 (58)	38,700 (65)	38,500 (69.5)	37,500 (73)	24,400 (76)	*24,400 (78)
35		45,150 (38)	44,900 (52.5)	38,700 (60.5)	36,750 (66)	33,150 (70)	24,400 (73.5)	24,400 (77)
40		35,250 (25.5)	34,700 (46)	36,750 (56)	32,750 (62)	29,550 (67)	24,400 (70.5)	24,250 (75)
45			27,600 (39)	29,450 (51)	29,400 (58.5)	26,500 (63.5)	24,400 (68)	21,900 (73)
50			22,400 (30)	24,000 (45.5)	25,650 (54.5)	23,950 (60.5)	22,050 (65)	19,800 (70.5)
55			18,250 (15.5)	19,850 (39.5)	21,350 (50)	21,750 (57)	20,000 (62)	17,900 (68.5)
60				16,600 (32.5)	17,950 (45.5)	18,900 (53.5)	18,250 (59)	16,150 (66)
65				13,850 (23)	15,200 (40)	16,150 (49.5)	16,700 (56)	14,650 (64)
70					12,950 (34.5)	13,850 (45.5)	14,800 (53)	12,850 (61.5)
75					11,000 (27.5)	11,950 (41)	12,900 (49.5)	10,950 (59)
80					9340 (17)	10,300 (36)	11,250 (45.5)	9380 (56.5)
85						8900 (30)	9830 (42)	7980 (54)
90						7640 (22.5)	8590 (37.5)	6770 (51)
95						6520 (8)	7510 (32.5)	5700 (48.5)
100							6520 (26.5)	4750 (45.5)
105							5640 (18.5)	3910 (42)
110								3150 (38.5)
115								2460 (35)
120								1840 (30.5)
125								1250 (25.5)

Minimum boom angle (deg) for indicated length (no load) _____ 24
 Maximum boom length (ft) at 0 deg boom angle (no load) _____ 115.4
 #LMI operating code. Refer to LMI manual for instructions.
 *This capacity is based upon maximum obtainable boom angle.
 Note: () Boom angles are in degrees.

Boom angle	Lifting capacities at zero degree boom angle							
	Main boom length in feet							
	37.3	50.4	63.4	76.4	89.4	102.4	115.4	
0°	27,500 (30.1)	17,300 (43.2)	11,050 (56.2)	8580 (69.2)	6700 (82.2)	5380 (95.2)	4280 (108.2)	

Note: () Reference radii in feet.

6-829-103320A

THIS CHART IS ONLY A GUIDE AND SHOULD NOT BE USED TO OPERATE THE CRANE.

Load charts (Mode A)

37.3 ft – 76.4 ft 22,000 lb Stationary 360°

Pounds				
Main boom				
Main boom length in feet				
Feet	37.3	50.4	63.4	76.4
12	39,500 (65)	41,650 (72.5)		
15	37,750 (59.5)	38,950 (68.5)	18,900 (73.5)	15,650 (77)
20	24,850 (49.5)	24,850 (62)	18,900 (68.5)	15,650 (73)
25	16,300 (36.5)	16,650 (55)	17,450 (63.5)	15,650 (69)
30	10,200 (12.5)	11,350 (47)	11,450 (58)	13,200 (65)
35		7650 (38)	7630 (52.5)	9280 (60.5)
40		4920 (25.5)	5020 (46)	6510 (56)
45				4490 (51)
Minimum boom angle (°) for indicated length (no load)			39	46
Maximum boom length (ft) at 0° boom angle (no load)			50.4	
Lifting capacities at zero degree boom angle				
Boom angle	Main boom length in feet			
	37.3	50.4		
0°	10,050 (30.1)	3150 (43.2)		

NOTE: () Reference radii in feet.

A6-829-103452A

#LMI operating code. Refer to LMI manual for instructions.

37.3 ft – 76.4 ft 22,000 lb Pick and carry up to 2.5 mph Boom centered over front

Pounds				
Main boom				
Main boom length in feet				
Feet	37.3	50.4	63.4	76.4
12	41,600 (65)	41,700 (72.5)		
15	41,600 (59.5)	41,700 (68.5)	22,400 (73.5)	15,650 (77)
20	36,250 (49.5)	36,450 (62)	22,400 (68.5)	15,650 (73)
25	27,600 (36.5)	28,250 (55)	22,400 (63.5)	15,650 (69)
30	21,300 (12.5)	22,200 (47)	22,400 (58)	15,650 (65)
35		17,500 (38)	17,950 (52.5)	15,650 (60.5)
40		13,800 (25.5)	14,350 (46)	15,650 (56)
45			11,000 (39)	12,500 (51)
50			8360 (30)	9820 (45.5)
55			6240 (15.5)	7690 (39.5)
Minimum boom angle (°) for indicated length (no load)				36
Maximum boom length (ft) at 0° boom angle (no load)				63.4
Lifting capacities at zero degree boom angle				
Boom angle	Main boom length in feet			
	37.3	50.4	63.4	
0°	21,150 (30.1)	11,600 (43.2)	5790 (56.2)	

A6-829-103453

#LMI operating code. Refer to LMI manual for instructions.

NOTES:

- Capacities are in pounds and do not exceed 75% of tipping loads as determined by test in accordance with SAE J765.
- Capacities are applicable to machines equipped with 29.5x25 (34 ply) General tires at 76 psi cold inflation pressure.
- Capacities appearing above the bold line are based on structural strength and tipping should not be relied upon as a capacity limitation.
- Capacities are applicable only with machine on firm level surface.
- On rubber lifting with boom extensions not permitted.
- For pick and carry operation, boom must be centered over front of machine, mechanical swing lock engaged and load restrained from swinging. When handling loads in the structural range with capacities close to maximum ratings, travel should be reduced to creep speeds.
- Axle lockouts must be functioning when lifting on rubber.
- All lifting depends on proper tire inflation, capacity and condition. Capacities must be reduced for lower tire inflation pressures. See lifting capacity chart for tire used. Damaged tires are hazardous to safe operation of crane.
- Creep – not over 200 ft of movement in any 30 minute period and not exceeding 1 mph.

THIS CHART IS ONLY A GUIDE AND SHOULD NOT BE USED TO OPERATE THE CRANE.

The individual crane's load chart, operating instructions and other instructional plates must be read and understood prior to operating the crane.

33 ft – 56 ft luffing bi-fold boom extension (Mode B) (fixed offsettable angles)



Pounds						
Feet	33 ft LENGTH			56 ft LENGTH		
	5° OFFSET #0091	20° OFFSET #0091	40° OFFSET #0091	5° OFFSET #0092	20° OFFSET #0092	40° OFFSET #0092
40	*13,700 (78)					
45	13,700 (77)					
50	13,700 (75)	13,700 (77.5)		*8200 (78)		
55	13,700 (73.5)	13,700 (75.5)	*11,000 (78)	8200 (77.5)		
60	13,700 (71.5)	13,700 (74)	11,000 (76)	8200 (76)		
65	13,700 (70)	12,850 (72)	10,950 (74.5)	8200 (74.5)	8200 (77.5)	
70	12,500 (68)	12,000 (70)	10,350 (72.5)	8200 (73)	8200 (76)	
75	11,350 (66)	11,200 (68)	9830 (70.5)	8200 (71.5)	8100 (74)	6400 (77.5)
80	9730 (64.5)	10,450 (66.5)	9330 (68.5)	8200 (69.5)	7600 (72.5)	6400 (76)
85	8300 (62.5)	8980 (64.5)	8860 (66.5)	8200 (68)	7150 (71)	6230 (74)
90	7060 (60.5)	7660 (62.5)	8210 (64.5)	7740 (66.5)	6730 (69)	5920 (72.5)
95	5960 (58.5)	6500 (60.5)	6980 (62)	7130 (64.5)	6350 (67.5)	5640 (70.5)
100	4990 (56.5)	5470 (58)	5880 (60)	6130 (63)	6000 (65.5)	5380 (68.5)
105	4120 (54)	4560 (56)	4900 (58)	5230 (61)	5690 (64)	5140 (67)
110	3340 (52)	3730 (54)	4020 (55.5)	4430 (59.5)	5290 (62)	4900 (65)
115	2640 (49.5)	2990 (51.5)	3230 (53)	3700 (57.5)	4490 (60)	4690 (63)
120	2000 (47.5)	2320 (49)	2510 (50.5)	3040 (55.5)	3760 (58.5)	4470 (61)
125	1420 (45)	1700 (46.5)	1850 (47.5)	2440 (53.5)	3100 (56.5)	3710 (58.5)
130		1140 (44)	1250 (45)	1900 (51.5)	2500 (54.5)	3030 (56.5)
135				1390 (49.5)	1940 (52)	2390 (54)
140					1420 (50)	1810 (52)
145						1270 (49)
Minimum boom angle (°) for indicated length (no load)	42	43	43	48	48	47
Maximum boom length (ft) at 0° boom angle (no load)		89.8			76.7	

NOTE: () Boom angles are in degrees. A6-829-103522
 #LMI operating code. Refer to LMI manual for operating instructions.
 *This capacity is based upon maximum boom angle.

NOTES:

- All capacities above the bold line are based on structural strength of boom extension and do not exceed 85% of tipping loads, in accordance with SAE J-765.
- The 33 ft luffing folding boom extension may be used for single or double line lifting service. The 56 ft luffing folding boom extension may be used for single line lifting service only. WARNING: Lifting with the 33 ft extension base, with the 23 ft extension fly either erected or folded along side of extension base, is strictly prohibited.
- WARNING: Operation of this machine with heavier loads than the capacities listed is strictly prohibited. Machine tipping with boom extension occurs rapidly and without advance warning.
- Boom angle is the angle above or below horizontal of the longitudinal axis of the boom base section after lifting rated load.
- Capacities listed are with outriggers properly extended and vertical jacks set only.
- For main boom lengths less than 141.7 ft with the boom extension erected, the rated loads are determined by boom angle. Use only the column which corresponds to the boom extension length and offset for which the machine is set up. For boom angles not shown, use rating of the next lower boom angle.
- When lifting over the main boom nose with 33 ft or 56 ft extension erected, the outriggers must be fully extended or 50% extended (17.3 ft spread).

THIS CHART IS ONLY A GUIDE AND SHOULD NOT BE USED TO OPERATE THE CRANE.

33 ft – 56 ft luffing bi-fold boom extension (Mode B) (intermediate offsettable angles)

 37.3 ft – 141.7 ft
  33 ft – 56 ft
  22,000 lb
  100%
  360°
 24 ft spread

Feet	Pounds			
	33 ft LENGTH		56 ft LENGTH	
	5° - 20° OFFSET #0091	20° - 40° OFFSET	5° - 20° OFFSET	20° - 40° OFFSET #0092
50	11,850			
55	11,550	10,750		
60	11,200	10,600		
65	10,900	10,450	6150	
70	10,650	10,350	5960	
75	10,350	9830	5780	5370
80	9730	9330	5610	5280
85	8300	8860	5450	5200
90	7060	7660	5310	5130
95	5960	6500	5170	5070
100	4990	5470	5040	5010
105	4120	4560	4920	4910
110	3340	3730	4430	4810
115	2640	2990	3700	4490
120	2000	2320	3040	3760
125	1420	1700	2440	3100
130		1140	1900	2500
135			1390	1940
140				1420
Min. boom angle for indicated length (no load)	43°	43°	48°	48°
Max. boom length at 5° boom angle (no load)	89.8'		76.7'	

#LMI operating code. Refer to LMI manual for operating instructions.

A6-829-103525A

NOTES:

- All capacities above the bold line are based on structural strength of boom extension and do not exceed 85% of tipping loads, in accordance with SAE J-765.
- The 33 ft luffing folding boom extension may be used for single or double line lifting service. The 56 ft luffing folding boom extension may be used for single line lifting service only.
WARNING: Lifting with the 33 ft extension base, with the 23 ft extension fly either erected or folded along side of extension base, is strictly prohibited.
- WARNING:** Operation of this machine with heavier loads than the capacities listed is strictly prohibited. Machine tipping with boom extension occurs rapidly and without advance warning.
- The loads for luffing depend on the angle of the main boom, angle of the boom extension and dynamic working pressure of the luffing cylinder for the boom extension.
- Capacities listed are with outriggers properly extended and vertical jacks set only.
- When lifting over the main boom nose with 33 ft or 56 ft extension erected, the outriggers must be fully extended or 50% extended (17.3 ft spread).

33 ft – 56 ft luffing bifold boom extension with inserts (Mode B) (intermediate offsettable angles)

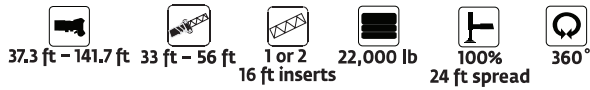

Pounds						
Feet	72 ft (56 ft LENGTH + 1 INSERT)			88 ft (56 ft LENGTH + 2 INSERTS)		
	5° OFFSET #0095	20° OFFSET #0095	40° OFFSET #0095	5° OFFSET #1095	20° OFFSET #1095	40° OFFSET #1095
55	*6400 (78)					
60	6400 (77.5)					
65	6400 (76)			*5000 (78)		
70	6400 (74.5)	*6400 (78)		5000 (77)		
75	6400 (73.5)	6400 (76.5)		5000 (75.5)	*5000 (78)	
80	6400 (72)	6400 (75)	*5500 (78)	5000 (74.5)	5000 (76)	
85	6400 (70.5)	6040 (73.5)	5420 (76)	5000 (73)	5000 (74.5)	*4460 (78)
90	6250 (69)	5630 (72)	5100 (74.5)	5000 (71.5)	4790 (73)	4460 (76.5)
95	5800 (67.5)	5260 (70.5)	4800 (73)	4740 (70)	4420 (71.5)	4150 (75)
100	5380 (66)	4910 (69)	4520 (71.5)	4350 (69)	4090 (70.5)	3860 (73.5)
105	5010 (64)	4610 (67.5)	4270 (69.5)	4010 (67.5)	3790 (69)	3600 (72)
110	4570 (62.5)	4310 (65.5)	4020 (68)	3680 (66)	3490 (67.5)	3340 (70.5)
115	3840 (61)	4040 (64)	3790 (66)	3390 (64.5)	3230 (66)	3110 (69)
120	3180 (59.5)	3780 (62.5)	3570 (64.5)	3110 (63)	2980 (64.5)	2890 (67.5)
125	2570 (57.5)	3290 (60.5)	3370 (62.5)	2720 (61.5)	2760 (63)	2680 (66)
130	2020 (56)	2680 (59)	3180 (60.5)	2160 (60)	2540 (61.5)	2480 (64.5)
135	1510 (54)	2120 (57)	2680 (59)	1640 (58.5)	2300 (59.5)	2300 (62.5)
140	1040 (52.5)	1600 (55)	2100 (57)	1170 (57)	1780 (58)	2120 (61)
145		1130 (53)	1560 (54.5)		1300 (56.5)	1820 (59)
150			1060 (52.5)			1320 (57)
Minimum boom angle (°) for indicated length (no load)	51	52	51	56	55	56
Maximum boom length (ft) at 0° boom angle (no load)		76.7			63.7	







NOTE: () Boom angles are in degrees. A6-829-103523
#LMI operating code. Refer to LMI manual for operating instructions.
*This capacity is based upon maximum boom angle.

NOTES:

- All capacities above the bold line are based on structural strength of boom extension and do not exceed 85% of tipping loads, in accordance with SAE J-765.
- The 56 ft luffing folding boom extension may be used for single line lifting service only.
- WARNING:** Operation of this machine with heavier loads than the capacities listed is strictly prohibited. Machine tipping with boom extension occurs rapidly and without advance warning.
- WARNING:** Lifting with the 33 ft extension base, with the 23 ft extension fly either erected or folded along side of extension base, or with either one or two 16 ft insert sections installed, is strictly prohibited.
- For main boom lengths less than 141.7 ft with the boom extension erected, the rated loads are determined by boom angle. Use only the column which corresponds to the boom extension length and offset for which the machine is set up. For boom angles not shown, use rating of the next lower boom angle.
- When lifting over the main boom nose with the 56 ft extension erected and inserts, the outriggers must be fully extended and vertical jacks set.

THIS CHART IS ONLY A GUIDE AND SHOULD NOT BE USED TO OPERATE THE CRANE.

33 ft – 56 ft luffing bi-fold boom extension with inserts (Mode B) (intermediate offsettable angles)

 37.3 ft – 141.7 ft
  33 ft – 56 ft
  1 or 2
16 ft inserts
  22,000 lb
  100%
24 ft spread
  360°

Feet	Pounds			
	72 ft LENGTH (56 ft + 1 INSERT)		88 ft LENGTH (56 ft + 2 INSERTS)	
	5° - 20° OFFSET	20° - 40° OFFSET	5° - 20°	20° - 40° OFFSET
	#0095	#1095		
70	6090			
75	5920		5000	
80	5750	5340	5000	
85	5600	5260	5000	4460
90	5460	5100	4790	4460
95	5260	4800	4420	4150
100	4910	4520	4090	3860
105	4610	4270	3790	3600
110	4310	4020	3490	3340
115	3840	3790	3230	3110
120	3180	3570	2980	2890
125	2570	3290	2720	2680
130	2020	2680	2160	2480
135	1510	2120	1640	2300
140	1040	1600	1170	1780
145		1130		1300
Min. boom angle for indicated length (no load)	52°	52°	56°	56°
Max. boom length at 5° boom angle (no load)	76.7		63.7	

A6-829-103526

#LMI operating code. Refer to LMI manual for operating instructions.

NOTES:

1. All capacities above the bold line are based on structural strength of boom extension and do not exceed 85% of tipping loads, in accordance with SAE J-765.
2. The 56 ft luffing folding boom extension may be used for single line lifting service only
WARNING: Lifting with the 33 ft extension base, with the 23 ft extension fly either erected or folded along side of extension base, or with either one or two 16 ft insert sections installed, is strictly prohibited.
3. WARNING: Operation of this machine with heavier loads than the capacities listed is strictly prohibited. Machine tipping with boom extension occurs rapidly and without advance warning.
4. The loads for luffing depend on the angle of the main boom, angle of the boom extension and dynamic working pressure of the luffing cylinder for the boom extension.
5. When lifting over the main boom nose with 56 ft extension erected and inserts, the outriggers must be fully extended and vertical jacks set only.

Load handling

Weight reductions for load handling devices

33 ft – 56 ft Folding boom extension

*33 ft extension (erected)	3750 lb
*56 ft extension (erected)	8000 lb
*72 ft (1 insert erected)	10,450 lb
*88 ft (2 inserts erected)	13,000 lb

*Reduction of main boom capacities
(no deduct required for stowed boom extension)

Auxiliary boom nose	133 lb
Hookblocks and headache balls:	
80 USt, 5 sheave	1600 lb +
90 USt, 5 sheave	1300 lb +
10 USt overhaul ball	568 lb +
+ Refer to rating plate for actual weight.	

When lifting over swingaway and/or jib combinations, deduct total weight of all load handling devices reeved over main boom nose directly from swingaway or jib capacity.

NOTE: All load handling devices and boom attachments are considered part of the load and suitable allowances **MUST BE MADE** for their combined weights. Weights are for Grove furnished equipment.

Line pulls and reeving information

Hoists	Cable specs	Permissible line pulls	Nominal cable length
Main	19 mm (3/4 in) 6x37 class, EIPS, IWRC special flexible min. breaking str. 58,800 lb	16,800 lb	600 ft
Main and Aux.	19 mm (3/4 in) Flex-X 35 rotation resistant (non-rotating) min. breaking strength 85,800 lb	16,800 lb	600 ft

The approximate weight of 3/4 in wire rope is 1.5 lb/ft

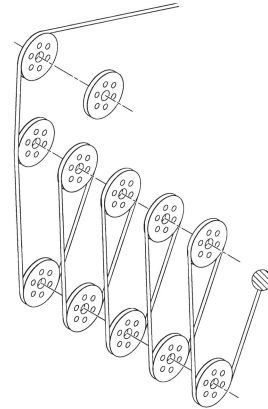

Installation and removal of counterweight and auxiliary hoist

Rated lifting capacities in pounds on outriggers fully extended –

Radius in feet	LMI Code #0801 Main boom length
	37.3 ft*
10	24,000
12	24,000
15	24,000
20	24,000
25	24,000
30	24,000

*The boom must be fully retracted.

A6-829-103450

Hoist performance

Wire rope layer	Hoist line pulls two speed hoist		Drum rope capacity (ft) 15 in drum	
	Low Available lb°	High Available lb°	Layer	Total
1	20,250	9610	101	101
2	18,490	8770	110	211
3	17,010	8070	120	331
4	15,750	7470	129	460
5	14,660	6960	139	599

*Max. lifting capacity: 6x37 or 35x7 class = 16,800 lb

Working area diagram

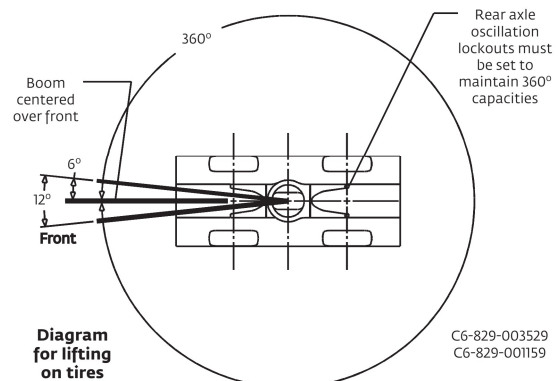
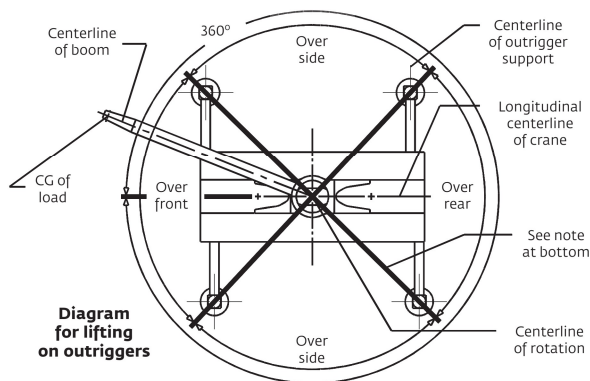

Bold lines determine the limiting position of any load for operation within working areas indicated.

THIS CHART IS ONLY A GUIDE AND SHOULD NOT BE USED TO OPERATE THE CRANE.

Notes

Notes

Manitowoc Cranes

Regional headquarters

Americas

Manitowoc, Wisconsin, USA

Tel: +1 920 684 6621

Fax: +1 920 683 6277

Shady Grove, Pennsylvania, USA

Tel: +1 717 597 8121

Fax: +1 717 597 4062

Europe, Middle East, Africa

Ecully, France

Tel: +33 (0)4 72 18 20 20

Fax: +33 (0)4 72 18 20 00

China

Shanghai, China

Tel: +86 21 6457 0066

Fax: +86 21 6457 4955

Greater Asia-Pacific

Singapore

Tel: +65 6264 1188

Fax: +65 6862 4040

Regional offices

Americas

Brazil

Alphaville

Mexico

Monterrey

Chile

Santiago

Europe, Middle East,

Africa

Czech Republic

Netvorice

France

Baudemont

Cergy

Decines

Germany

Langenfeld

Hungary

Budapest

Italy

Lainate

Netherlands

Breda

Poland

Warsaw

Portugal

Baltar

Russia

Moscow

U.A.E.

Dubai

U.K.

Buckingham

China

Beijing

Chengdu

Guangzhou

Xian

Greater Asia-Pacific

Australia

Adelaide

Brisbane

Melbourne

Sydney

India

Calcutta

Chennai

Delhi

Hyderabad

Pune

Korea

Seoul

Philippines

Makati City

Singapore

Factories

Brazil

Alphaville

China

TaiAn

Zhangjiagang

France

Charlieu

Moulins

Germany

Wilhelmshaven

India

Pune

Italy

Niella Tanaro

Portugal

Baltar

Fânzeres

Slovakia

Saris

USA

Manitowoc

Port Washington

Shady Grove

This document is non-contractual. Constant improvement and engineering progress make it necessary that we reserve the right to make specification, equipment, and price changes without notice. Illustrations shown may include optional equipment and accessories and may not include all standard equipment.