

Mobile Crane Grue mobile

LTM 1095-5.1

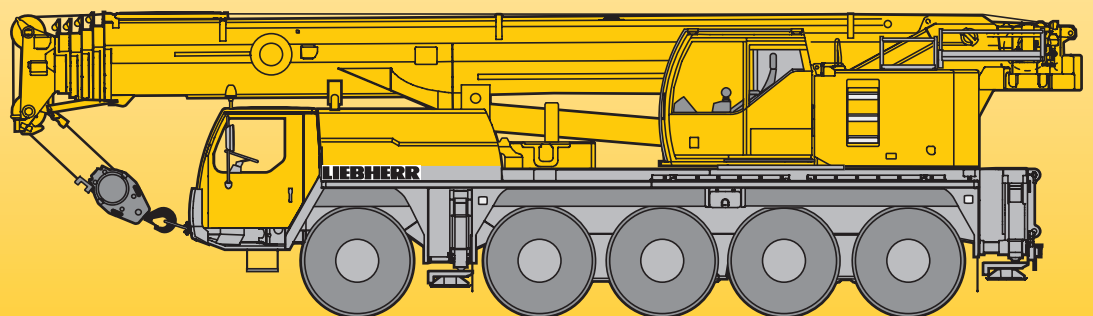



Technical Data Caractéristiques techniques



LIEBHERR

Lifting capacities on telescopic boom

Forces de levage à la flèche télescopique

41 - 190 ft    360°  50700 lbs **85%**





ft	41 ft		54 ft	68 ft	82 ft	96 ft	110 ft	123 ft	137 ft	151 ft	165 ft	178 ft	190 ft	ft
	*													
9	230	181	140											9
10	224	179	140	129										10
12	158	158	139	129	107									12
14	149	147	134	125	107	84								14
16	141	134	126	118	107	84	73							16
18	130	122	119	111	103	84	72	49.4						18
20	118	110	111	105	98.5	84	71	49.4	44.1					20
23	99.5	96	97.5	97	90.5	84	69	49.4	44.1					23
26	85.5	83	85	84	83	80	66.5	49.4	42.5	33.2				26
29	75	73	74.5	74	74.5	70.5	63	48	40.6	32.7	25			29
32	66	65	66.5	65.5	66.5	62.5	59.8	45.5	38.5	31.6	24.7	19.4		32
35			59.3	59.5	59.1	55.9	54.9	42.9	36.4	30.5	24.1	19.4	15	35
38			53.4	54	53.1	51.8	49.8	40.5	34.5	29.3	23.4	19.2	15	38
44			44.2	44.8	44	44.1	41.6	36.1	31	26.8	22	18.4	14.4	44
50				38.1	38.1	37.4	35.2	32.2	28	24.4	20.5	17.5	13.6	50
56				32.9	33.2	32.2	30.2	28.6	25.4	22.2	19.1	16.4	13	56
62					28.6	28	26.1	25.7	23.1	20.3	17.7	15.3	12.4	62
68					24.9	24.4	22.9	23.2	20.6	18.7	16.5	14.3	11.8	68
74						21.3	20.7	20.6	18.2	17.2	15.4	13.4	11.2	74
80						18.7	19.2	18.3	16.6	15.7	14.2	12.6	10.6	80
86							17.2	16.3	15.2	13.9	13.2	11.9	10	86
92							15.3	14.3	14.1	12.4	12.2	11.1	9.5	92
98							13.8	12.8	13.1	11.5	11.2	10.4	8.9	98
104								11.4	11.7	10.7	9.9	9.8	8.4	104
110								10.6	10.5	9.8	9.1	9.1	7.9	110
116									9.4	9.2	8.5	8.2	7.5	116
122									8.6	8.5	8	7.4	7.1	122
128										7.7	7.4	6.6	6.5	128
134										7.1	6.7	5.9	5.8	134
140											6.1	5.3	5.2	140
146											5.5	4.7	4.6	146
152												4.1	4.1	152
158												3.6	3.6	158
164												3.1	3.1	164
170													2.6	170
176													2.2	176

* over rear - en arrière

TAB 1580301 / 1580391

Lifting capacities on telescopic boom

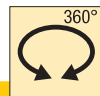
Forces de levage à la flèche télescopique

41 - 190 ft     **85%**

ft	41 ft	54 ft	68 ft	82 ft	96 ft	110 ft	123 ft	137 ft	151 ft	165 ft	178 ft	190 ft	ft
9	183	140											9
10	181	140	129										10
12	158	139	129	107									12
14	145	134	125	107	84								14
16	130	126	118	107	84	73							16
18	117	116	111	103	84	72	49.4						18
20	105	106	104	97.5	83.5	71	49.4	44.1					20
23	88.5	90.5	86.5	83.5	77.5	69	49.4	44.1					23
26	76.5	78	75.5	71.5	66.5	64.5	49.4	42.5	33.2				26
29	66.5	68	65.5	62	60.5	57	48	40.6	32.7	25			29
32	58.5	59.6	57.2	54.8	53.8	50.4	45.5	38.5	31.6	24.7	19.4		32
35		52.7	50.7	49.9	47.9	44.8	41.8	36.4	30.5	24.1	19.4	15	35
38		47.1	46.2	45.1	42.9	40.1	38.3	34.5	29.3	23.4	19.2	15	38
44		37.9	38.4	37	35.2	33.2	32.7	29.5	26.8	22	18.4	14.4	44
50			31.8	30.9	29.4	28.5	27.8	25.5	23.9	20.5	17.5	13.6	50
56			26.5	26.2	24.9	25	23.6	22.1	20.6	19.1	16.4	13	56
62				22.4	21.4	21.9	20.3	19.6	18	17.3	15.3	12.4	62
68				19.1	18.5	19	17.7	17.7	16.3	15.3	14.3	11.8	68
74					16	16.5	15.9	15.5	14.5	13.5	13.3	11.2	74
80					13.8	14.3	14.6	13.7	13.1	12.6	11.8	10.6	80
86						12.6	13	12.1	12	11.4	10.3	10	86
92						11.3	11.4	10.9	10.5	10	9.1	8.9	92
98						10.4	10.1	10	9.3	8.8	7.9	7.8	98
104							9	8.9	8.2	7.7	6.9	6.8	104
110							8.2	8	7.3	6.8	6	5.9	110
116								7.2	6.5	6	5.3	5.1	116
122								6.5	5.8	5.3	4.6	4.4	122
128									5.2	4.7	3.9	3.8	128
134									4.5	4.1	3.3	3.2	134
140										3.5	2.8	2.7	140
146										3			146

TAB 1580394

41 - 190 ft     **85%**

ft	41 ft	54 ft	68 ft	82 ft	96 ft	110 ft	123 ft	137 ft	151 ft	165 ft	178 ft	190 ft	ft
9	183	140											9
10	181	140	129										10
12	158	139	129	107									12
14	144	134	125	107	84								14
16	129	126	118	107	84	73							16
18	116	116	110	102	84	72	49.4						18
20	103	105	102	94.5	83.5	71	49.4	44.1					20
23	87	89	83.5	80.5	75	69	49.4	44.1					23
26	75	76.5	72.5	68.5	66.5	62.5	49.4	42.5	33.2				26
29	65	65.5	63	59.4	58.5	54.8	48	40.6	32.7	25			29
32	57.2	57.2	55	53.8	51.6	48.2	44.6	38.5	31.6	24.7	19.4		32
35		50.4	49.6	48.2	45.7	42.7	40.5	36.4	30.5	24.1	19.4	15	35
38		45.3	44.7	43	40.9	38.1	36.6	33.9	29.3	23.4	19.2	15	38
44		36.2	36.6	35.2	33.5	31.6	31.1	28.5	26.7	22	18.4	14.4	44
50			30.2	29.4	27.9	27.5	26.3	24.3	23	20.5	17.5	13.6	50
56			25.2	24.9	23.6	24	22.3	21.5	19.8	18.8	16.4	13	56
62				21.2	20.3	20.7	19.3	19.1	17.6	16.6	15.3	12.4	62
68				18.2	17.5	18	17.2	16.7	15.7	14.6	14.2	11.8	68
74					15	15.6	15.6	14.6	14	13.4	12.7	11.2	74
80					13	13.5	13.9	12.9	12.7	12.1	11	10.5	80
86						12.2	12.2	11.6	11.2	10.6	9.6	9.4	86
92						11.2	10.6	10.6	9.8	9.2	8.3	8.2	92
98						10	9.4	9.3	8.6	8.1	7.2	7.1	98
104							8.5	8.3	7.6	7.1	6.3	6.2	104
110							7.6	7.4	6.7	6.3	5.4	5.3	110
116								6.6	6	5.5	4.7	4.6	116
122								5.9	5.3	4.8	4	3.9	122
128									4.7	4.2	3.4	3.3	128
134									4	3.6	2.8	2.7	134
140										3			140
146										2.5			146

TAB 1580395

Lifting heights Hauteurs de levage

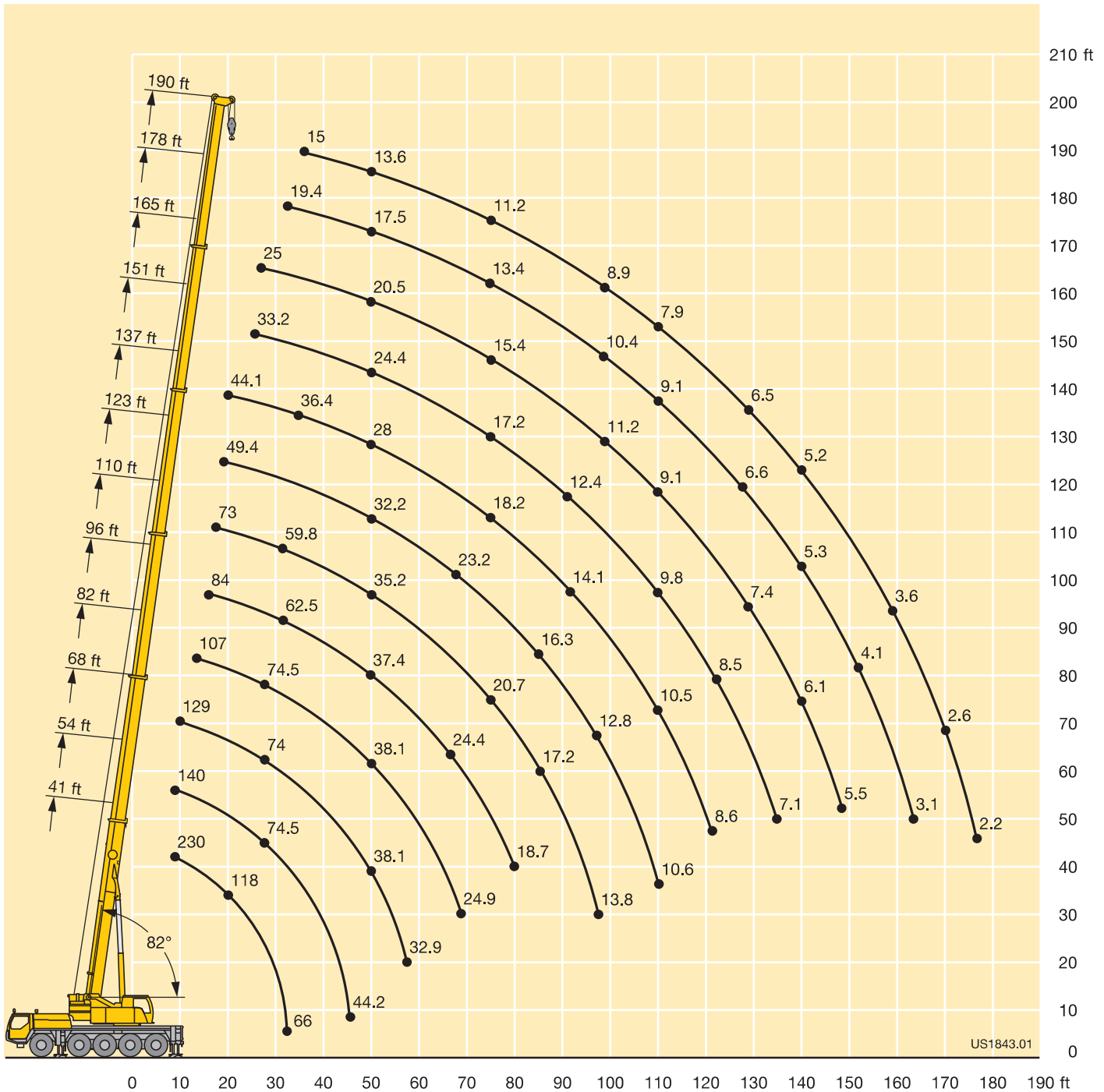

Lifting capacities on the hydraulically or mechanically variable folding jib Forces de levage à la fléchette pliante à variation hydraulique ou mécanique



ft	41 ft			96 ft			110 ft			123 ft			137 ft			ft
	34 ft			34 ft			34 ft			34 ft			34 ft			
	0°	20°	40°	0°	20°	40°	0°	20°	40°	0°	20°	40°	0°	20°	40°	
12	25.1			25.1												12
14	25.1	22.1		25.1												14
17	25.1	21.9		25.1			25.1									17
20	25	21.3	16.4	25.1			25.1			24.3						20
23	23.9	20.2	16.4	25.1			25.1			24.3						23
26	22.4	19.3	16.2	25.1			25.1			24.3			20.6			26
29	20.8	18.4	15.7	25.1	22.1		25.1			24.3			20.6			29
32	19.4	17.6	15.3	25.1	21.5		25.1	21.1		24.3			20.6			32
35	18.1	16.7	14.9	25.1	20.9	16.4	25.1	20.8		24	19.9		20.6			35
38	16.9	15.8	14.6	25.1	20.3	16.2	25.1	20.3	16	23.6	19.7		20.5	18.2		38
44	15	14.1	13.6	24.2	19.3	15.7	24.2	19.4	15.7	22.7	18.9	15.3	20.2	17.9	14.8	44
50	13.4	12.8	12.5	22.6	18.3	15.2	22.9	18.5	15.2	21.7	18.2	15	19.7	17.3	14.6	50
56	12.1	11.7	11.6	20.8	17.4	14.8	21.5	17.6	14.8	20.8	17.4	14.7	18.9	16.8	14.4	56
62	10.9	10.8		19.1	16.4	14.5	20.1	16.8	14.5	19.8	16.7	14.4	17.8	16.3	14.1	62
68				17.6	15.4	14	18.7	16	14.2	18.8	16	14.1	16.5	15.6	13.9	68
74				16.4	14.4	13.4	17.4	15.1	13.8	17.6	15.3	13.8	15.1	14.8	13.6	74
80				15.2	13.6	12.8	16.2	14.3	13.3	15.9	14.5	13.4	13.9	13.8	13.2	80
86				14.3	12.9	12.3	15.2	13.6	12.8	14.2	13.8	12.9	12.9	12.8	12.6	86
92				13.3	12.2	11.8	13.9	12.9	12.3	13.1	13.2	12.4	11.8	11.9	12	92
98				12.6	11.7	11.4	12.5	12.4	11.9	11.7	12.3	12.1	10.5	11	11.2	98
104				11.9	11.2	11.2	11.1	11.5	11.5	10.5	11.1	11.4	9.3	10	10.3	104
110				10.8	10.8		9.9	10.3	10.4	9.3	9.8	10.1	8.3	8.8	9.3	110
116				9.8	10		8.9	9.2	8.8	8.3	8.7	9	7.7	7.9	8.2	116
122							8.1	8.3		7.4	7.8	8	7.2	7.3	7.4	122
128							7.2	7.4		6.6	6.9	7.1	6.5	6.8	6.9	128
134										5.8	6.1		5.7	6.1	6.2	134
140										5	5.3		4.9	5.3	5.4	140
146													4.3	4.6		146
152													3.7	3.9		152

TAB 1580321 / 1580331 / 1580341



ft	151 ft			165 ft			178 ft			190 ft			ft
	34 ft			34 ft			34 ft			34 ft			
	0°	20°	40°	0°	20°	40°	0°	20°	40°	0°	20°	40°	
29	17												29
32	17			12.4									32
35	17			12.4			9.7						35
38	17			12.4			9.7				7.8		38
44	17	16.3		12.4	12.4		9.7				7.8		44
50	16.6	15.8	13.8	12.3	12		9.6	9.5			7.8	7.8	50
56	15.8	15.1	13.7	12	11.5	10.9	9.4	9.3	8.7		7.8	7.8	56
62	14.8	14.2	13.4	11.5	10.9	10.6	9.1	8.9	8.6		7.8	7.7	62
68	13.8	13.3	12.9	10.9	10.4	10	8.7	8.5	8.4		7.7	7.5	68
74	12.9	12.4	12.2	10.3	9.8	9.5	8.4	8.1	8.1		7.5	7.3	74
80	12	11.6	11.4	9.6	9.3	9.1	8	7.8	7.7		7.2	7	80
86	11.2	10.9	10.7	9.1	8.8	8.6	7.6	7.4	7.4		6.9	6.7	86
92	10.3	10.2	10.1	8.5	8.3	8.3	7.3	7.1	7.1		6.5	6.5	92
98	9.5	9.5	9.5	8	7.9	7.9	6.9	6.8	6.8		6.2	6.2	98
104	8.8	8.8	8.9	7.6	7.5	7.6	6.6	6.5	6.5		5.9	5.9	104
110	7.9	8.2	8.3	7.2	7.1	7.2	6.3	6.2	6.2		5.7	5.7	110
116	7	7.6	7.8	6.8	6.8	6.8	6	5.9	6		5.4	5.4	116
122	6.4	6.7	7.1	6.3	6.4	6.5	5.7	5.7	5.7		5.1	5.2	122
128	6	6.1	6.3	5.6	6	6.2	5.4	5.4	5.5		4.9	4.9	128
134	5.6	5.7	5.7	5.1	5.4	5.7	5.1	5.2	5.3		4.6	4.7	134
140	5.1	5.3	5.4	4.8	4.9	5.1	4.5	4.9	5		4.3	4.4	140
146	4.4	4.8	5	4.5	4.6	4.6	4	4.4	4.6		3.7	4.1	146
152	3.9	4.2	4.3	4.2	4.3	4.4	3.4	3.8	4		3.2	3.6	152
158	3.7	3.8		3.7	4	4.1	2.9	3.3	3.5		2.7	3.1	158
164	3.5	3.6		3.2	3.4	3.5	2.4	2.8	2.9		2.3	2.6	164
170	3.2	3.3		2.7	2.9		1.9	2.3	2.4		1.9	2.2	170
176				2.3	2.4				1.9				176
182				1.9	2								182

TAB 1580321 / 1580331 / 1580341

Lifting capacities on the hydraulically or mechanically variable folding jib Forces de levage à la fléchette pliante à variation hydraulique ou mécanique



ft	41 ft			96 ft			110 ft			123 ft			137 ft			ft
	62 ft			62 ft			62 ft			62 ft			62 ft			
	0°	20°	40°	0°	20°	40°	0°	20°	40°	0°	20°	40°	0°	20°	40°	
12	9															12
14	9															14
17	9															17
20	9			9												20
23	9			9												23
26	8.7			9			8.5									26
29	8.5	7.3		9			8.5			7.8						29
32	8.2	7.3		9			8.5			7.8			7.3			32
35	8	7.3		9			8.5			7.8			7.3			35
38	7.7	7.2		9			8.5			7.8			7.3			38
44	7	6.9		8.5	7.3		8.5			7.8			7.3			44
50	6.3	6.5	5.8	8.3	7.3		8.3	7		7.8	6.8		7.3			50
56	5.7	6	5.7	8.1	7.1		8	7		7.7	6.8		7.3	6.6		56
62	5.1	5.5	5.5	7.7	6.9	5.8	7.7	6.8	5.8	7.5	6.7		7.3	6.5		62
68	4.6	4.9	5.2	7.3	6.6	5.8	7.4	6.6	5.8	7.2	6.5	5.6	7.1	6.4	5.6	68
74	4.2	4.5	4.8	6.8	6.4	5.7	7	6.3	5.7	6.9	6.3	5.6	6.9	6.2	5.6	74
80	3.9	4.1	4.3	6.3	6.1	5.6	6.6	6.1	5.6	6.5	6.1	5.5	6.6	6.1	5.5	80
86	3.6	3.7		5.9	5.8	5.5	6.2	5.9	5.5	6.2	5.9	5.5	6.3	6	5.4	86
92				5.6	5.4	5.4	5.8	5.6	5.4	5.8	5.6	5.4	6	5.7	5.3	92
98				5.2	5.1	5.1	5.5	5.3	5.3	5.4	5.4	5.2	5.6	5.4	5.3	98
104				4.9	4.8	4.8	5.2	5.1	5	5.1	5.1	5	5.3	5.2	5.1	104
110				4.6	4.5	4.6	4.9	4.8	4.8	4.8	4.8	4.8	5	5	4.9	110
116				4.3	4.3	4.3	4.7	4.6	4.6	4.5	4.6	4.6	4.8	4.7	4.7	116
122				4	4	4.1	4.4	4.4	4.4	4.2	4.3	4.4	4.5	4.5	4.5	122
128				3.8	3.8	3.9	4.2	4.2	4.2	4	4.1	4.2	4.3	4.3	4.4	128
134				3.6	3.6		4	4	4	3.8	3.8	3.9	4	4.1	4.2	134
140				3.4	3.5		3.8	3.8	3.9	3.5	3.6	3.7	3.8	3.9	4	140
146							3.6	3.6		3.3	3.4	3.5	3.6	3.7	3.8	146
152							3.5	3.5		3.1	3.2	3.3	3.5	3.5	3.6	152
158										3	3		3.3	3.3	3.4	158
164										2.8	2.9		3.1	3.2	3.2	164
170										2.7	2.7		3	3	3.1	170
176										2.5			2.9	2.9		176
182													2.7	2.8		182
188													2.6			188

Lifting capacities on the hydraulically or mechanically variable folding jib Forces de levage à la fléchette pliante à variation hydraulique ou mécanique



ft	151 ft			165 ft			178 ft			190 ft			ft
	62 ft			62 ft			62 ft			62 ft			
	0°	20°	40°	0°	20°	40°	0°	20°	40°	0°	20°	40°	
35	7.3												35
38	7.3			6.8									38
44	7.3			6.8			5.6						44
50	7.3			6.8			5.6			4.6			50
56	7.3	6.6		6.8			5.6			4.6			56
62	7.3	6.6		6.8	6.3		5.6			4.6			62
68	7.3	6.5		6.8	6.3		5.6	5.6		4.6	4.6		68
74	7.2	6.4	5.5	6.7	6.2	5.3	5.6	5.6		4.6	4.6		74
80	7	6.2	5.5	6.6	6	5.3	5.6	5.6	5.1	4.5	4.6		80
86	6.9	6.1	5.4	6.6	5.9	5.3	5.6	5.5	5.1	4.5	4.6	4.6	86
92	6.7	6	5.4	6.5	5.8	5.3	5.6	5.4	5.1	4.4	4.6	4.6	92
98	6.5	5.8	5.3	6.4	5.7	5.2	5.4	5.3	5	4.3	4.6	4.6	98
104	6.3	5.7	5.3	6.2	5.6	5.2	5.2	5.1	5	4.3	4.6	4.6	104
110	6	5.6	5.2	6	5.5	5.1	5	4.9	4.8	4.2	4.5	4.5	110
116	5.7	5.5	5.2	5.7	5.4	5.1	4.9	4.8	4.7	4.2	4.4	4.3	116
122	5.5	5.3	5.1	5.5	5.3	5.1	4.7	4.6	4.6	4.1	4.2	4.2	122
128	5.2	5.1	5	5.2	5.2	5.1	4.5	4.4	4.4	4	4.1	4.1	128
134	4.9	5	4.9	5	5	5	4.3	4.3	4.3	3.9	3.9	4	134
140	4.7	4.7	4.8	4.7	4.8	4.8	4.1	4.1	4.1	3.7	3.8	3.8	140
146	4.4	4.5	4.6	4.2	4.6	4.7	3.9	3.9	4	3.5	3.6	3.7	146
152	4.2	4.3	4.4	3.7	4.3	4.5	3.7	3.8	3.9	3.3	3.4	3.6	152
158	4	4.1	4.2	3.5	3.8	4.3	3.3	3.6	3.7	3	3.3	3.4	158
164	3.5	3.9	4	3.4	3.4	3.8	2.8	3.5	3.6	2.6	3.2	3.2	164
170	3.1	3.6	3.8	3.2	3.3	3.4	2.4	3	3.4	2.2	2.8	3.1	170
176	2.7	3.1	3.2	2.8	3.1	3.2	2	2.6	2.9		2.4	2.8	176
182	2.6	2.7	2.8	2.4	2.8	3		2.2	2.5		2	2.4	182
188	2.4	2.5		2	2.4	2.6		1.8	2			1.9	188
194	2.2	2.3		1.6	2	2.1							194
200	1.9												200

Lifting capacities on the hydraulically or mechanically variable folding jib

Forces de levage à la fléchette pliante à variation hydraulique ou mécanique



ft	41 ft			96 ft			110 ft			123 ft			137 ft			ft
	34 ft			34 ft			34 ft			34 ft			34 ft			
	0°	20°	40°	0°	20°	40°	0°	20°	40°	0°	20°	40°	0°	20°	40°	
12	25.1															12
14	25.1	22.1		25.1												14
17	25.1	21.9		25.1			25.1									17
20	25	21.3	16.4	25.1			25.1			24.3						20
23	23.9	20.2	16.4	25.1			25.1			24.3						23
26	22.4	19.3	16.2	25.1			25.1			24.3			20.6			26
29	20.8	18.4	15.7	25.1	22.1		25.1			24.3			20.6			29
32	19.4	17.6	15.3	25.1	21.5		25.1	21.1		24.3			20.6			32
35	18.1	16.7	14.9	25.1	20.9	16.4	25.1	20.8		24	19.9		20.6			35
38	16.9	15.8	14.6	25.1	20.3	16.2	25.1	20.3	16	23.6	19.7		20.5	18.2		38
44	15	14.1	13.6	24.2	19.3	15.7	24.2	19.4	15.7	22.7	18.9	15.3	20.2	17.9	14.8	44
50	13.4	12.8	12.5	22.6	18.3	15.2	22.9	18.5	15.2	21.7	18.2	15	19.7	17.3	14.6	50
56	12.1	11.7	11.6	20.8	17.4	14.8	20.9	17.6	14.8	19.8	17.4	14.7	18.1	16.8	14.4	56
62	10.9	10.8		19.1	16.4	14.5	18.3	16.8	14.5	17.2	16.7	14.4	15.8	16.1	14.1	62
68				17.2	15.4	14	15.9	15.9	14.2	14.7	15.6	14.1	13.9	14.7	13.9	68
74				15	14.4	13.4	13.8	14.6	13.8	12.7	13.8	13.7	12.3	12.8	13.3	74
80				13.2	13.5	12.8	12	12.9	13.2	11	12	12.8	10.6	11.5	11.8	80
86				11.7	12.3	12.2	10.5	11.3	11.9	9.5	10.4	11.1	9.2	10.1	10.7	86
92				10.2	10.8	11.2	9.2	9.9	10.4	8.2	9	9.7	7.9	8.8	9.4	92
98				8.9	9.4	9.6	8.1	8.7	9.1	7.1	7.8	8.4	6.9	7.6	8.2	98
104				7.9	8.3	8.4	7.1	7.6	7.9	6.2	6.8	7.2	5.9	6.6	7.1	104
110				7	7.3		6.1	6.6	6.8	5.6	5.9	6.2	5	5.6	6.1	110
116				6.1	6.3		5.2	5.7	5.8	5.2	5.3	5.4	4.3	4.8	5.2	116
122							4.5	4.8		4.9	4.9	5	3.6	4.1	4.4	122
128							3.8	4		4.6	4.6	4.7	3	3.4	3.7	128
134										4.3	4.4			2.8	3	134
140										3.8	4					140

TAB 1580325 / 1580335 / 1580345



ft	151 ft			165 ft			178 ft			190 ft			ft	
	34 ft			34 ft			34 ft			34 ft				
	0°	20°	40°	0°	20°	40°	0°	20°	40°	0°	20°	40°		
29	17												29	
32	17			12.4									32	
35	17			12.4			9.7						35	
38	17			12.4			9.7				7.8		38	
44	17	16.3		12.4	12.4		9.7				7.8		44	
50	16.6	15.8	13.8	12.3	12		9.6	9.5			7.8	7.8	50	
56	15.8	15.1	13.7	12	11.5	10.9	9.4	9.3	8.7		7.8	7.8	56	
62	14.6	14.2	13.4	11.5	10.9	10.6	9.1	8.9	8.6		7.8	7.7	7.5	62
68	13	13.3	12.9	10.9	10.4	10	8.7	8.5	8.4		7.7	7.5	7.5	68
74	11.2	12.1	12.2	10.3	9.8	9.5	8.4	8.1	8.1		7.5	7.3	7.3	74
80	10.1	10.6	11.3	9.5	9.3	9.1	8	7.8	7.7		7.2	7	7	80
86	9.1	9.1	9.9	8.3	8.7	8.6	7.6	7.4	7.4		6.9	6.7	6.7	86
92	7.9	8.6	8.5	7.3	7.9	8.3	7.3	7.1	7.1		6.5	6.5	6.5	92
98	6.9	7.6	8	7	6.9	7.4	6.2	6.8	6.8		6	6.2	6.2	98
104	6.4	6.6	7.1	6.2	6.5	6.6	5.3	6	6.5		5.1	5.7	5.9	104
110	6	6.1	6.3	5.4	6	6.2	4.5	5.2	5.7		4.3	5	5.4	110
116	5.3	5.7	5.8	4.7	5.2	5.6	3.7	4.4	4.9		3.5	4.2	4.7	116
122	4.7	5.1	5.3	4	4.5	4.9	3.1	3.7	4.1		2.9	3.5	3.9	122
128	4	4.5	4.7	3.4	3.8	4.2		3	3.4			2.8	3.3	128
134	3.5	3.8	4.1	2.8	3.2	3.5			2.8				2.6	134
140	2.9	3.3	3.5		2.7	3								140
146	2.4	2.7	2.9											146

TAB 1580325 / 1580335 / 1580345

Lifting capacities on the hydraulically or mechanically variable folding jib

Forces de levage à la fléchette pliante à variation hydraulique ou mécanique



ft	41 ft			96 ft			110 ft			123 ft			137 ft			ft
	62 ft			62 ft			62 ft			62 ft			62 ft			
	0°	20°	40°	0°	20°	40°	0°	20°	40°	0°	20°	40°	0°	20°	40°	
12	9															12
14	9															14
17	9															17
20	9			9												20
23	9			9												23
26	8.7			9			8.5									26
29	8.5	7.3		9			8.5			7.8						29
32	8.2	7.3		9			8.5			7.8			7.3			32
35	8	7.3		9			8.5			7.8			7.3			35
38	7.7	7.2		9			8.5			7.8			7.3			38
44	7	6.9		8.5	7.3		8.5			7.8			7.3			44
50	6.3	6.5	5.8	8.3	7.3		8.3	7		7.8	6.8		7.3			50
56	5.7	6	5.7	8.1	7.1		8	7		7.7	6.8		7.3	6.6		56
62	5.1	5.5	5.5	7.7	6.9	5.8	7.7	6.8	5.8	7.5	6.7		7.3	6.5		62
68	4.6	4.9	5.2	7.3	6.6	5.8	7.4	6.6	5.8	7.2	6.5	5.6	7.1	6.4	5.6	68
74	4.2	4.5	4.8	6.8	6.4	5.7	7	6.3	5.7	6.9	6.3	5.6	6.9	6.2	5.6	74
80	3.9	4.1	4.3	6.3	6.1	5.6	6.6	6.1	5.6	6.5	6.1	5.5	6.6	6.1	5.5	80
86	3.6	3.7		5.9	5.8	5.5	6.2	5.9	5.5	6.2	5.9	5.5	6.3	6	5.4	86
92				5.6	5.4	5.4	5.8	5.6	5.4	5.8	5.6	5.4	6	5.7	5.3	92
98				5.2	5.1	5.1	5.5	5.3	5.3	5.4	5.4	5.2	5.6	5.4	5.3	98
104				4.9	4.8	4.8	5.2	5.1	5	5.1	5.1	5	5.3	5.2	5.1	104
110				4.6	4.5	4.6	4.9	4.8	4.8	4.8	4.8	4.8	5	5	4.9	110
116				4.3	4.3	4.3	4.7	4.6	4.6	4.5	4.6	4.6	4.8	4.7	4.7	116
122				4	4	4.1	4.4	4.4	4.4	4.2	4.3	4.4	4.5	4.5	4.5	122
128				3.8	3.8	3.9	4.2	4.2	4.2	4	4.1	4.2	4.3	4.3	4.4	128
134				3.6	3.6		4	4	4	3.8	3.8	3.9	4	4.1	4.2	134
140				3.4	3.5		3.8	3.8	3.9	3.5	3.6	3.7	3.8	3.9	4	140
146							3.6	3.6	3.9	3.3	3.4	3.5	3.6	3.7	3.8	146
152							3.5	3.5		3.1	3.2	3.3	3.2	3.5	3.6	152
158										3	3		2.7	3.2	3.4	158
164										2.6	2.9		2.3	2.7	2.9	164
170										2.3	2.5		1.9	2.2	2.3	170
176										1.9				1.8		176

TAB 1580325 / 1580335 / 1580345



ft	151 ft			165 ft			178 ft			190 ft			ft
	62 ft			62 ft			62 ft			62 ft			
	0°	20°	40°	0°	20°	40°	0°	20°	40°	0°	20°	40°	
35	7.3												35
38	7.3			6.8									38
44	7.3			6.8			5.6						44
50	7.3			6.8			5.6				4.6		50
56	7.3	6.6		6.8			5.6				4.6		56
62	7.3	6.6		6.8	6.3		5.6				4.6		62
68	7.3	6.5		6.8	6.3		5.6	5.6			4.6	4.6	68
74	7.2	6.4	5.5	6.7	6.2	5.3	5.6	5.6			4.6	4.6	74
80	7	6.2	5.5	6.6	6	5.3	5.6	5.6	5.1		4.5	4.6	80
86	6.9	6.1	5.4	6.6	5.9	5.3	5.6	5.5	5.1		4.5	4.6	86
92	6.7	6	5.4	6.5	5.8	5.3	5.6	5.4	5.1		4.4	4.6	92
98	6.5	5.8	5.3	6.4	5.7	5.2	5.4	5.3	5		4.3	4.6	98
104	6.3	5.7	5.3	6.4	5.6	5.2	5.2	5.1	5		4.3	4.6	104
110	5.7	5.6	5.2	6.4	5.5	5.1	4.8	4.9	4.8		4.2	4.5	110
116	5	5.5	5.2	6.4	5.1	5.1	4.1	4.8	4.7		3.8	4.4	116
122	4.6	5.1	5.1	6.4	4.7	5.1	3.5	4.5	4.6		3.2	4.2	122
128	4.3	4.6	5	6.4	4.4	4.7	2.9	3.9	4.4		2.6	3.7	128
134	3.8	4.2	4.6	6.4	4.1	4.3		3.3	4.1			3.1	134
140	3.3	3.9	4.1	6.4	2.7	3.5	4	2.7	3.4			2.5	140
146	2.9	3.5	3.8	6.4	3	3.5			2.9				146
152	2.4	3	3.5	6.4	2.5	3							152
158		2.6	2.9	6.4		2.5							158
164		2.1	2.5	6.4		2							164
170			2	6.4									170

TAB 1580325 / 1580335 / 1580345

Lifting heights Hauteurs de levage

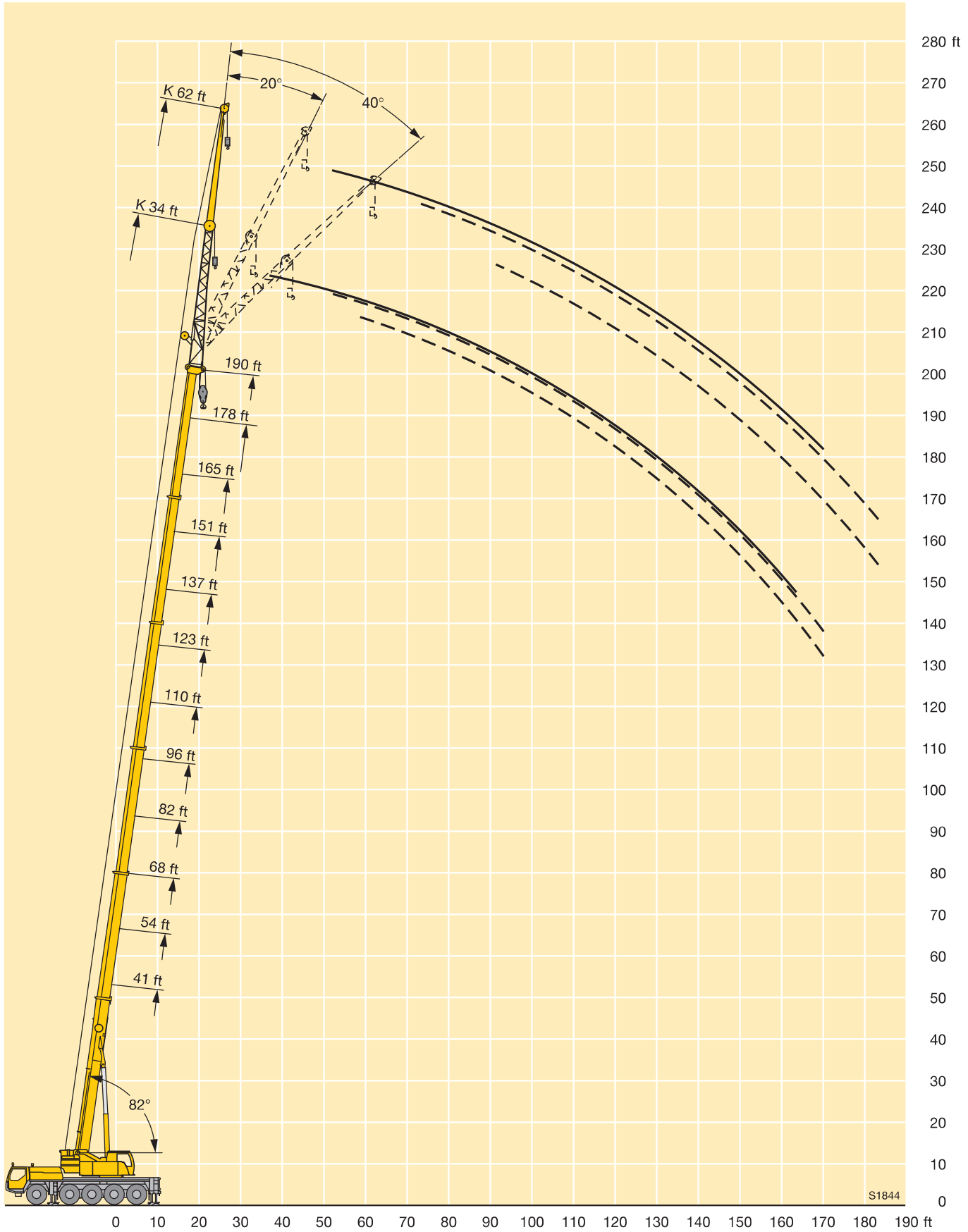

Lifting capacities on the hydraulically or mechanically variable folding jib with boom extension

Forces de levage à la fléchette pliante à variation hydraulique ou mécanique avec télescope rallongé



ft	41 ft + 23 ft			151 ft + 23 ft			165 ft + 23 ft			178 ft + 23 ft			190 ft + 23 ft			ft
	34 ft			34 ft			34 ft			34 ft			34 ft			
	0°	20°	40°	0°	20°	40°	0°	20°	40°	0°	20°	40°	0°	20°	40°	
10	7.8															10
12	7.8															12
14	7.8															14
16	7.8															16
18	7.8	7.8														18
20	7.7	7.8														20
23	7.6	7.8														23
26	7.3	7.6														26
29	6.9	7.3	7													29
32	6.6	6.9	7													32
35	6.2	6.5	6.9													35
38	5.8	6.2	6.5	7.8												38
44	5.2	5.6	5.9	7.8			7			6.3						44
50	4.6	5	5.3	7.8	7.7		7	7		6.3			5.3			50
56	4.1	4.4	4.7	7.7	7.5	7	7	7		6.3	6.3		5.3			56
62	3.6	3.9	4.2	7.4	7.1	6.9	7	6.8	6.6	6.3	6.3	6.3	5.3	5.3		62
68	3.1	3.5	3.7	7	6.8	6.7	6.8	6.6	6.5	6.3	6.3	6.2	5.3	5.3	5.3	68
74	2.7	3	3.2	6.7	6.5	6.4	6.5	6.3	6.2	6.2	6.1	6	5.2	5.3	5.3	74
80	2.3	2.5	2.7	6.3	6.1	6.1	6.3	6.1	6	6	5.9	5.8	5.1	5.2	5.2	80
86				6	5.8	5.8	6	5.8	5.7	5.8	5.6	5.6	5	5.1	5	86
92				5.7	5.6	5.5	5.7	5.5	5.5	5.6	5.4	5.4	4.9	4.9	4.8	92
98				5.4	5.3	5.3	5.4	5.3	5.3	5.3	5.2	5.2	4.7	4.7	4.7	98
104				5.1	5.1	5	5.1	5.1	5	5	5	5	4.6	4.5	4.5	104
110				4.8	4.8	4.8	4.9	4.8	4.8	4.8	4.8	4.8	4.4	4.3	4.3	110
116				4.5	4.5	4.6	4.6	4.6	4.6	4.6	4.6	4.6	4.2	4.1	4.2	116
122				4.3	4.3	4.4	4.4	4.4	4.4	4.4	4.4	4.4	4	4	4	122
128				4	4.1	4.1	4.2	4.2	4.2	4.2	4.2	4.2	3.8	3.8	3.8	128
134				3.8	3.8	3.9	4	4	4	4	4	4	3.6	3.6	3.7	134
140				3.6	3.6	3.7	3.8	3.8	3.8	3.8	3.8	3.8	3.4	3.5	3.5	140
146				3.4	3.4	3.5	3.6	3.6	3.6	3.6	3.6	3.7	3.2	3.3	3.3	146
152				3.1	3.2	3.3	3.4	3.4	3.5	3.2	3.4	3.5	2.9	3.1	3.2	152
158				2.9	3	3.1	3.2	3.2	3.3	2.7	3.1	3.3	2.4	2.9	3	158
164				2.7	2.8	2.9	3	3.1	3.1	2.2	2.6	2.8	2	2.4	2.6	164
170				2.5	2.6	2.7	2.6	2.9	2.9		2.1	2.3		1.9	2.2	170
176				2.4	2.4	2.5	2.2	2.5	2.6			1.9				176
182				2.2	2.3		1.8	2	2.1							182
188				1.9	2											188
194				1.6	1.6											194

Lifting capacities on the hydraulically or mechanically variable folding jib with boom extension

Forces de levage à la fléchette pliante à variation hydraulique ou mécanique avec télescope rallongé



ft	41 ft + 23 ft			151 ft + 23 ft			165 ft + 23 ft			178 ft + 23 ft			188 ft + 23 ft			ft
	62 ft			62 ft			62 ft			62 ft			62 ft			
	0°	20°	40°	0°	20°	40°	0°	20°	40°	0°	20°	40°	0°	20°	40°	
14	5.1															14
16	5.1															16
18	5.1															18
20	5.1															20
23	5.1															23
26	5.1															26
29	5.1															29
32	5															32
35	4.9	4.6														35
38	4.8	4.6														38
44	4.6	4.6		5.1												44
50	4.2	4.4	4.1	5.1			4.4			3.9						50
56	3.8	4.2	4.1	5.1			4.4			3.9			2.9			56
62	3.5	3.9	4	5.1	4.6		4.4			3.9			2.9			62
68	3.3	3.5	3.8	5.1	4.6		4.4	4.4		3.9			2.9			68
74	3.1	3.2	3.5	5	4.6		4.4	4.4		3.9	3.9		2.9	2.9		74
80	2.9	2.9	3.2	4.8	4.6	4.1	4.4	4.4	4.1	3.9	3.9		2.9	2.9		80
86	2.6	2.7	2.9	4.7	4.4	4.1	4.4	4.3	4.1	3.9	3.9	3.6	2.9	2.9		86
92	2.4	2.4	2.6	4.5	4.3	4.1	4.4	4.1	4.1	3.9	3.9	3.6	2.9	2.9		92
98	2.2	2.1	2.3	4.3	4.1	4.1	4.2	4	4	3.9	3.9	3.6	2.9	2.9	2.9	98
104	2	1.8	1.9	4.1	4	3.9	4.1	3.9	3.9	3.8	3.8	3.6	2.8	2.9	2.9	104
110	1.8	1.7	1.7	3.9	3.8	3.8	3.9	3.8	3.7	3.7	3.6	3.6	2.7	2.9	2.9	110
116	1.5			3.7	3.7	3.7	3.7	3.6	3.6	3.6	3.6	3.5	2.7	2.9	2.9	116
122				3.5	3.5	3.5	3.6	3.5	3.5	3.5	3.5	3.4	2.7	2.9	2.9	122
128				3.3	3.3	3.3	3.4	3.4	3.4	3.4	3.3	3.3	2.7	2.8	2.9	128
134				3.2	3.2	3.2	3.3	3.2	3.2	3.2	3.2	3.2	2.6	2.8	2.9	134
140				3	3	3.1	3.1	3.1	3.1	3.1	3.1	3.1	2.6	2.7	2.8	140
146				2.8	2.9	2.9	2.9	2.9	3	2.9	2.9	3	2.5	2.6	2.7	146
152				2.7	2.7	2.8	2.8	2.8	2.8	2.8	2.8	2.8	2.4	2.5	2.6	152
158				2.5	2.6	2.7	2.6	2.7	2.7	2.7	2.7	2.7	2.3	2.4	2.5	158
164				2.4	2.5	2.5	2.5	2.5	2.6	2.5	2.6	2.6	2.2	2.3	2.4	164
170				2.2	2.3	2.4	2.4	2.4	2.5	2.1	2.5	2.5	1.9	2.2	2.3	170
176				2.1	2.2	2.3	2.2	2.3	2.4		2.3	2.4		2.1	2.2	176
182				1.9	2	2.1	2.1	2.2	2.3		1.9	2.3		1.8	2.1	182
188				1.8	1.9	2	1.8	2.1	2.1		1.9				1.8	188
194				1.6	1.8	1.8		1.9	2							194
200					1.6	1.6										200

Lifting capacities on the hydraulically or mechanically variable folding jib with boom extension

Forces de levage à la fléchette pliante à variation hydraulique ou mécanique avec télescope rallongé



ft	41 ft + 23 ft			151 ft + 23 ft			165 ft + 23 ft			178 ft + 23 ft			190 ft + 23 ft			ft
	34 ft			34 ft			34 ft			34 ft			34 ft			
	0°	20°	40°	0°	20°	40°	0°	20°	40°	0°	20°	40°	0°	20°	40°	
10	7.8															10
12	7.8															12
14	7.8															14
16	7.8															16
18	7.8	7.8														18
20	7.7	7.8														20
23	7.6	7.8														23
26	7.3	7.6														26
29	6.9	7.3	7													29
32	6.6	6.9	7													32
35	6.2	6.5	6.9													35
38	5.8	6.2	6.5	7.8												38
44	5.2	5.6	5.9	7.8			7			6.3						44
50	4.6	5	5.3	7.8	7.7		7	7		6.3			5.3			50
56	4.1	4.4	4.7	7.7	7.5	7	7	7		6.3	6.3		5.3			56
62	3.6	3.9	4.2	7.4	7.1	6.9	7	6.8	6.6	6.3	6.3	6.3	5.3	5.3		62
68	3.1	3.5	3.7	7	6.8	6.7	6.8	6.6	6.5	6.3	6.3	6.2	5.3	5.3	5.3	68
74	2.7	3	3.2	6.7	6.5	6.4	6.5	6.3	6.2	6.2	6.1	6	5.2	5.3	5.3	74
80	2.3	2.5	2.7	6.3	6.1	6.1	6.3	6.1	6	6	5.9	5.8	5.1	5.2	5.2	80
86				6	5.8	5.8	6	5.8	5.7	5.8	5.6	5.6	5	5.1	5	86
92				5.7	5.6	5.5	5.7	5.5	5.5	5.6	5.4	5.4	4.9	4.9	4.8	92
98				5.4	5.3	5.3	5.4	5.3	5.3	5.3	5.2	5.2	4.7	4.7	4.7	98
104				5.1	5.1	5	5.1	5.1	5	5	5	5	4.6	4.5	4.5	104
110				4.8	4.8	4.8	4.9	4.8	4.8	4.2	4.8	4.8	4	4.3	4.3	110
116				4.5	4.5	4.6	4.4	4.6	4.6	3.5	4.2	4.5	3.3	3.9	4.2	116
122				4.2	4.3	4.4	3.7	4.2	4.4	2.8	3.5	3.9		3.3	3.7	122
128				3.8	4	4.1	3.1	3.6	4		2.8	3.3			3.1	128
134				3.2	3.7	3.8		3.1	3.4			2.6				134
140				2.7	3.1	3.4		2.5	2.8							140
146					2.6	2.8										146

Lifting capacities on the hydraulically or mechanically variable folding jib with boom extension

Forces de levage à la fléchette pliante à variation hydraulique ou mécanique avec télescope rallongé



ft	41 ft + 23 ft			151 ft + 23 ft			165 ft + 23 ft			178 ft + 23 ft			188 ft + 23 ft			ft
	62 ft			62 ft			62 ft			62 ft			62 ft			
	0°	20°	40°	0°	20°	40°	0°	20°	40°	0°	20°	40°	0°	20°	40°	
14	5.1															14
16	5.1															16
18	5.1															18
20	5.1															20
23	5.1															23
26	5.1															26
29	5.1															29
32	5															32
35	4.9	4.6														35
38	4.8	4.6														38
44	4.6	4.6		5.1												44
50	4.2	4.4	4.1	5.1			4.4			3.9						50
56	3.8	4.2	4.1	5.1			4.4			3.9			2.9			56
62	3.5	3.9	4	5.1	4.6		4.4			3.9			2.9			62
68	3.3	3.5	3.8	5.1	4.6		4.4	4.4		3.9			2.9			68
74	3.1	3.2	3.5	5	4.6		4.4	4.4		3.9	3.9		2.9	2.9		74
80	2.9	2.9	3.2	4.8	4.6	4.1	4.4	4.4	4.1	3.9	3.9		2.9	2.9		80
86	2.6	2.7	2.9	4.7	4.4	4.1	4.4	4.3	4.1	3.9	3.9	3.6	2.9	2.9		86
92	2.4	2.4	2.6	4.5	4.3	4.1	4.4	4.1	4.1	3.9	3.9	3.6	2.9	2.9		92
98	2.2	2.1	2.3	4.3	4.1	4.1	4.2	4	4	3.9	3.9	3.6	2.9	2.9	2.9	98
104	2	1.8	1.9	4.1	4	3.9	4.1	3.9	3.9	3.8	3.8	3.6	2.8	2.9	2.9	104
110	1.8	1.7	1.7	3.9	3.8	3.8	3.9	3.8	3.7	3.7	3.6	3.6	2.7	2.9	2.9	110
116	1.5			3.7	3.7	3.7	3.7	3.6	3.6	3.6	3.6	3.5	2.7	2.9	2.9	116
122				3.5	3.5	3.5	3.6	3.5	3.5	3.1	3.4	3.4	2.7	2.9	2.9	122
128				3.3	3.3	3.3	3.3	3.4	3.4		3.3	3.3		2.8	2.9	128
134				3.2	3.2	3.2	2.8	3.2	3.2		3	3.2		2.7	2.9	134
140				2.9	3	3.1		3	3.1		2.5	3			2.8	140
146				2.5	2.9	2.9		2.7	3			2.7			2.6	146
152					2.7	2.8			2.8							152
158					2.3	2.7										158
164					1.9	2.3										164
170						1.9										170

Lifting heights Hauteurs de levage

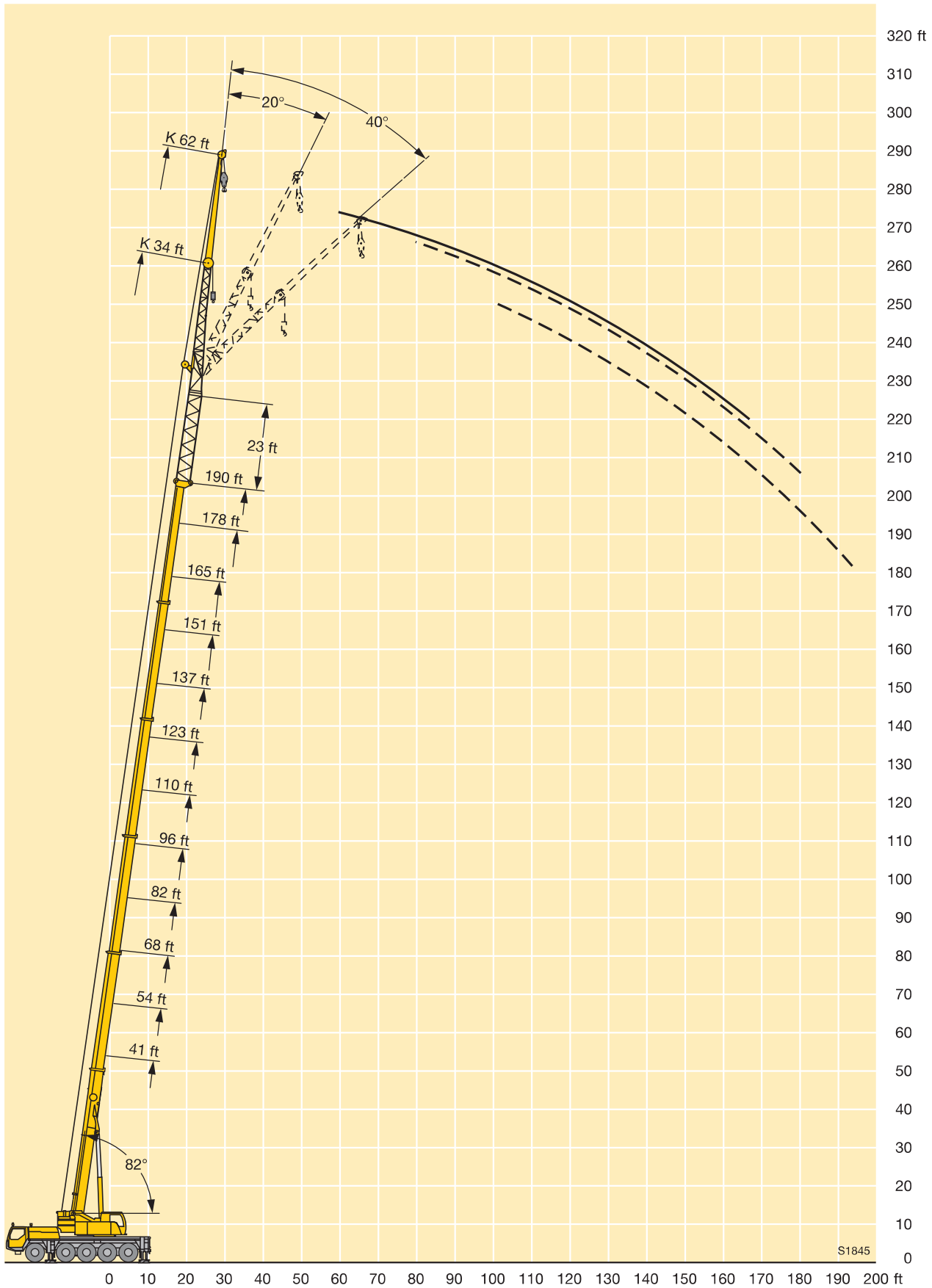

Dimensions Encombrement

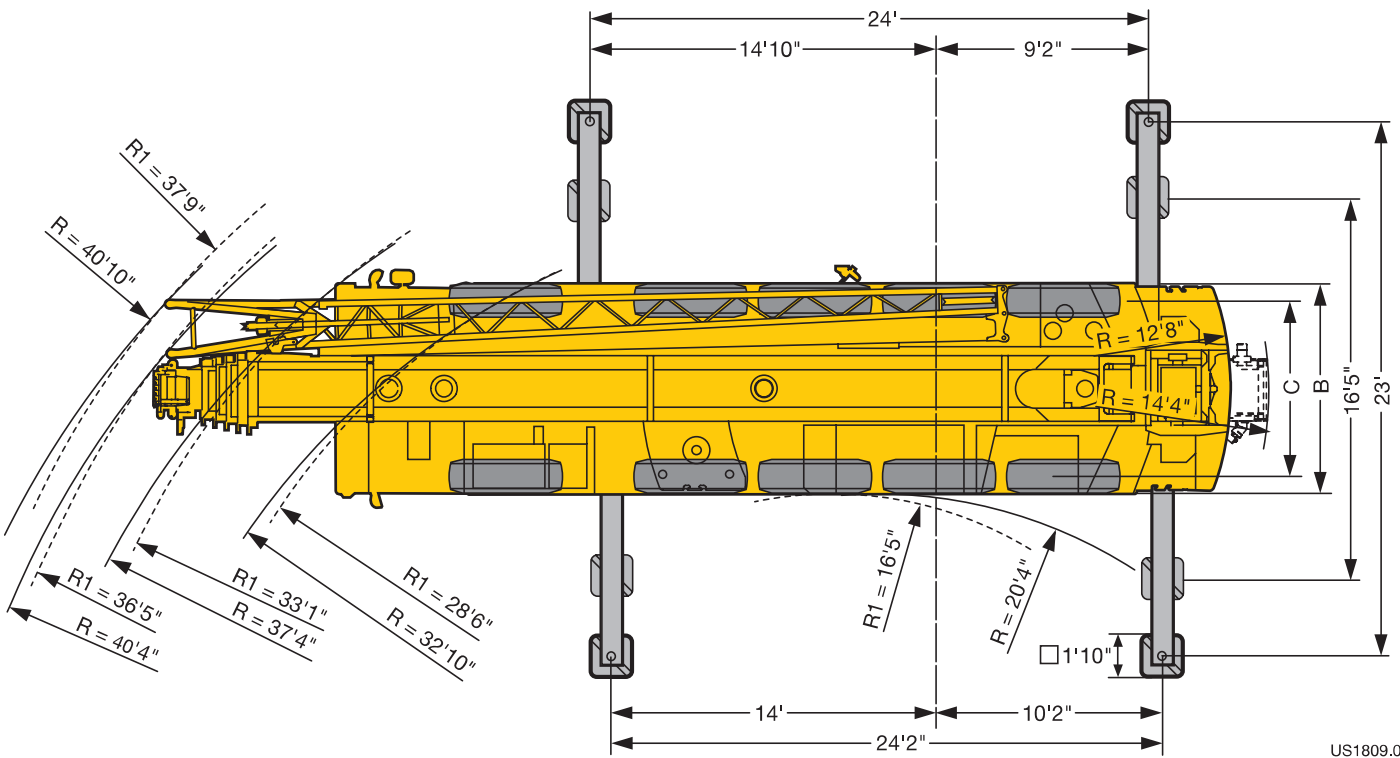
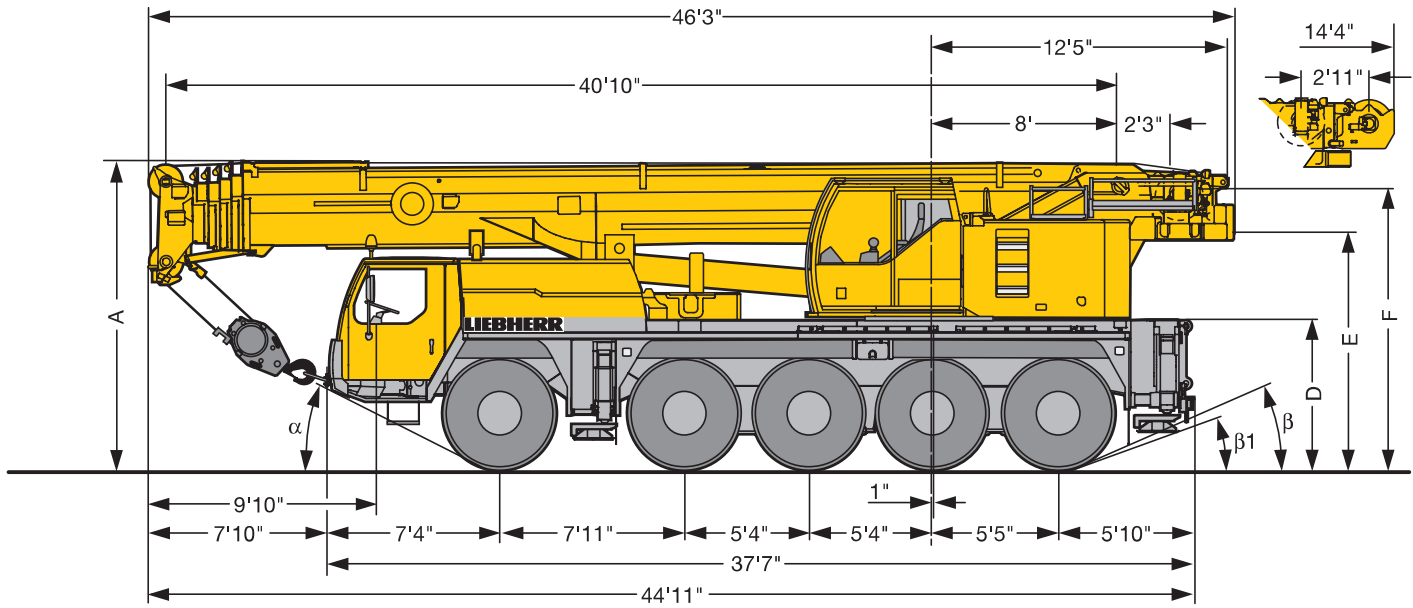

US1809.01

R₁ = All-wheel steering · Direction toutes roues

Dimensions · Encombrement										
	A	A 0'6" *	B	C	D	E	F	α	β	β ₁
16.00 R 25	13'1"	12'10"	9'	7'7"	6'4"	10'1"	12'3"	20°	20°	17°
20.5 R 25	13'1"	12'10"	9'9"	8'	6'4"	10'1"	12'3"	20°	20°	17°

* lowered · abaissé

Weights Poids



Axle Essieu lbs	1	2	3	4	5	Total weight (lbs) Poids total lbs
	26400	26400	26400	26400	26400	132000 ¹⁾

¹⁾ with 33100 lbs counterweight and folding jib · avec contrepoids 33100 lbs et flèche pliante



Load (kips) Forces de levage kips	No. of sheaves Poulies	No. of lines Brins	Weight lbs Poids lbs
176.4	7	14	1102
128.7	5	11	1102
84.4	3	7	992
35.3	1	3	661
12.6	–	1	308

Working speeds Vitesses



		1	2	3	4	5	6	7	8	9	10	11	12	R 1	R 2	
16.00 R 25 20.5 R 25	mph	1.2 – 3.5	4.5	5.8	7.5	9.5	12.2	16.1	20.6	26.6	34.2	43.4	50	1.3 – 3.8	4.9	43 %
		0.53 – 1.6	2	2.6	3.3	4.2	5.3	7	9	11.6	14.9	18.9	24.2	0.57 – 1.7	2.1	55 %



Drive Mécanismes	infinitely variable en continu	Rope diameter / Rope length Diamètre du câble / Longueur du câble	Max. single line pull Effort au brin maxi.
	0 – 393 ft/min single line ft/min au brin simple	0.7" / 853'	12820 lbs
	0 – 393 ft/min single line ft/min au brin simple	0.7" / 853'	12820 lbs
	0 – 1.7 rpm		
	approx. 60 seconds to reach 82° boom angle env. 60 s jusqu'à 82°		
	approx. 390 seconds for boom extension from 41 ft – 190 ft env. 390 s pour passer de 41 ft – 190 ft		

Equipment Equipement

Crane carrier

Frame	Self-manufactured, weight-optimized and torsion resistant box-type design of high-tensile structural steel.
Outriggers	4-point supporting system, hydraulically telescopic into horizontal and vertical direction. Automatic levelling of crane. Electronic inclination indicator. Supporting area lighting.
Engine	6-cylinder Diesel, make Liebherr, type D846 A7, watercooled, output 370 kW (503 h.p.) at 1900 min ⁻¹ , max. torque 1731 lbs-ft at 1100 – 1500 min ⁻¹ . Exhaust emissions acc. to 97/68/EG stage 3 and EPA/CARB Tier 3. Fuel reservoir: 127 gallons.
Transmission	ZF 12-speed gear box with automatic control system AS-TRONIC. ZF-intarder fitted directly to the gear. Two-stage transfer case with lockable transfer differential.
Axles	Welded design, made of high-tensile fine grained steel. All axles steerable. Axles 2, 4 and 5 are planetary axles with differential locks.
Suspension	All axles are mounted on hydropneumatic suspension and are lockable hydraulically.
Tyres	10 tyres, size: 16.00 R 25.
Steering	ZF-servocom power steering, dual circuit system with hydraulic servo system and auxiliary pump system, driven by the axle. At road displacement, axles 3, 4 and 5 electro-hydraulically speed-dependent and from 18.6 mph, axles 3 and 4 are fixed to straight displacement. From 37 mph, axle 5 is fixed straight. Steering according to EG directive 70/311 EWG.
Brakes	Service brake: Dual circuit, all-wheel servo-air brake. Parking brake: Spring brake actuator acting on all the wheels of axles 1, 2, 3 and 4. Sustained-action brakes: Engine brake as exhaust retarder with Liebherr additional brake system ZBS. Intarder on gear. Brakes according to EG directives 71/320 EWG resp. 70/311 EWG.
Driver's cab	Spacious, steel made, corrosion resistant cab, cataphoretic dip-primed, on resilient suspension with hydraulic shock absorbers, sound and heat absorbing internal panelling acc. to EG directive, safety glazing, operating and control instruments, comfortably equipped.
Electrical system	Modern data bus technique, 24 Volt DC, 2 batteries of 170 Ah each, lighting according to traffic regulations.

Crane superstructure

Frame	Self-manufactured, cataphoretic dip-primed weight-optimized and torsion resistant welded design of high-tensile structural steel; linked by a triple-row roller slewing ring to the carrier for continuous rotation.
Crane engine	4-cylinder Diesel, make Liebherr, type D934S A6, watercooled, output 145 kW (197 h.p.) at 1800 min ⁻¹ , max. torque 677 lbs-ft at 1100 min ⁻¹ – 1500 min ⁻¹ . Exhaust emissions acc. to 97/68/EG stage 3 and EPA/CARB Tier 3. Fuel reservoir: 68 gallons.
Crane drive	Diesel-hydraulic with 1 axial piston variable displacement pump, with servo-control and capacity control. 1 double gear pump, open controlled oil circuits. Compact hydraulic drive flanged to the Diesel engine. Drive assembly completely enclosed for noise abatement.
Control	Electric "Load Sensing" control, simultaneous operation of 4 working motions, 2 self-centering hand control levers (joy-stick type), with winch and slewing gear signal devices.
Hoist gear	Axial piston fixed displacement motor, Liebherr hoist drum with integrated planetary gear and spring-loaded static brake.
Luffing gear	1 differential ram with safety check valves.
Slewing gear	Axial piston fixed displacement motor, planetary gear, spring-loaded static brake. Slewing gear invertible from released to locked as standard feature.
Crane cab	All-steel construction, entirely galvanized, powder coated, with safety glazing, operating and control instruments, comfortably equipped, cab tiltable backwards.
Safety devices	LICCON safe load indicator, test system hoist limit switch, safety valves to prevent pipe and hose ruptures.
Telescopic boom	Buckling and torsion resistant design of high-tensile structural steel, oviform boom profile, 1 base section and 5 telescopic sections. All telescopic sections hydraulically extendable independent of one another. Rapid-cycle telescoping system "Telematik". Boom length: 41 ft – 190 ft.
Counterweight	33100 lbs basic counterweight.
Electrical system	Modern data bus technique, 24 Volt DC, 2 batteries of 170 Ah each.

Additional equipment

Swing-away jib	34 ft – 62 ft long, mountable to the telescopic boom at 0°, 20° or 40°. Hydraulic ram for operating the swing-away jib from 0° – 40° (option).
Erection jib	9 ft
Telescopic boom extension	23 ft long lattice section, thus 23 ft higher pinning point for swing-away jib.
2nd hoist gear	For two-hook operation or for operation with swing-away jib if the hoist rope shall remain reeved.
Additional counterweight	17600 lbs for a total counterweight of 50700 lbs.
Tyres	10 tyres, size 20.5 R 25.
Drive 10 x 8	Additional drive of the 1 st axle.

Other items of equipment available on request.

Equipment Equipment

Châssis porteur

Cadre	Construction en caisse résistante à la torsion et optimisée en poids réalisée par Liebherr en acier de construction à grain fin très rigide.
Stabilisateurs	Dispositif de calage horizontal et vertical en 4 points, entièrement déployable hydrauliquement. Nivellement automatique du calage. Indicateurs électroniques d'inclinaison. Eclairage de la zone de calage.
Moteur	Moteur diesel, 6 cylindres, fabriqué par Liebherr, de type D846 A7, à refroidissement par eau, de 370 kW (503 ch) à 1900 min ⁻¹ , couple max. 1731 lbs-ft à 1100 – 1500 min ⁻¹ . Emissions des gaz d'échappement conformes aux directives 97/68/EG partie 3 et EPA/CARB Tier 3. Capacité du réservoir à carburant: 127 gallons.
Boîte de vitesse	Boîte de vitesses ZF à 12 rapports, mécanisme automatisé à commande AS-TRONIC. Ralentisseur hydrodynamique ZF directement accouplé à la boîte. Boîte de transfert à 2 étages avec blocage de différentiel.
Essieux	Construction soudée en acier haute résistance à grains fins pour l'ensemble des 5 essieux. Tous les essieux sont directeurs. Essieux 2, 4 et 5 planétaires avec blocage du différentiel.
Suspension	Suspension hydropneumatique sur tous les essieux. Chaque essieu peut être bloqué hydrauliquement.
Pneumatiques	10 pneus de taille: 16.00 R 25.
Direction	Direction hydraulique ZF Servocom, à 2 circuits, assistée hydrauliquement, avec pompe auxiliaire entraînée par essieu. Lors de déplacements sur route, les essieux 3, 4 et 5 sont dirigés électrohydrauliquement en fonction de la vitesse, et à partir de 18.6 mph, les essieux 3 et 4 sont fixés en marche rectiligne. A partir d'env. 37 mph, l'essieu 5 est fixé en marche rectiligne. Direction conforme aux directives européennes 70/311 CE.
Freins	Frein de service: servofrein pneumatique pour toutes les roues, à 2 circuits. Frein à main: accumulateur à ressort agissant sur les roues des essieux 1, 2, 3 et 4. Freins continus: frein moteur par clapet sur échappement avec système de ralentissement Liebherr ZBS. Ralentisseur accouplé à la boîte de vitesses. Freins conformes aux directives européennes 71/320 CE resp. 70/311 CE.
Cabine du conducteur	Cabine spacieuse en tôle d'acier, traitement anticorrosion par bain de cataphorèse, avec suspension élastique et amortisseurs hydrauliques, revêtement intérieur avec isolation phonique et thermique selon les directives européennes, glaces de sécurité, appareils de commande et de contrôle, équipement confortable.
Installation électrique	Technique moderne de transmission de données par BUS de données, courant continu 24 Volts, 2 batteries de 170 Ah chacune, éclairage conforme au code de la route.

Partie tournante

Cadre	Construction soudée résistante à la torsion et optimisée en poids réalisée par Liebherr en acier de construction à grain fin très rigide. Couronne d'orientation à rouleaux à 3 rangées permettant une rotation illimitée sert de pièce de liaison avec le châssis de la grue.
--------------	--

Moteur	Moteur diesel Liebherr, 4 cylindres, de type D934S A6, à refroidissement par eau, de 145 kW (197 ch) à 1800 min ⁻¹ , couple max. 677 lbs-ft à 1100 min ⁻¹ – 1500 min ⁻¹ . Emissions des gaz d'échappement conformes aux directives 97/68/EG partie 3 et EPA/CARB Tier 3. Capacité du réservoir à carburant: 68 gallons.
Entraînement de la grue	Diesel hydraulique avec 1 double pompe à débit variable à pistons axiaux, avec servocommande et régulation de la puissance. 1 double pompe à engrenages, circuits hydrauliques ouverts et régulés. Entraînement hydraulique compact, accouplé directement au moteur diesel, mécanisme d'entraînement complet fermé pour une bonne insonorisation.
Direction	Commande électrique «Load Sensing», 4 mouvements de travail dirigeables simultanément, deux leviers de commande à 4 positions et à autocentrage, avec capteur de rotation des treuils et du mécanisme d'orientation.
Mécanisme de levage	Moteur à cylindrée constante et à pistons axiaux. Treuil de marque Liebherr équipé d'un engrenage planétaire et d'un frein d'arrêt commandé par ressort.
Mécanisme de relevage	1 vérin différentiel avec soupapes de retenu.
Dispositif de rotation	Moteur à cylindrée constante à pistons axiaux, réducteur planétaire, frein d'arrêt commandé par ressort. Commutation en série du mécanisme d'orientation: ouvert et en orientation freinée automatiquement.
Cabine du grutier	Construction en tôle d'acier entièrement zinguée avec peinture par poudrage et cuisson au four, avec glaces de sécurité, appareils de commande et de contrôle, équipement confortable, cabine inclinable vers l'arrière.
Dispositif de sécurité	Contrôleur de charge «LICCON», système test limitation de la course pour le levage, soupape de sûreté contre la rupture de tubes et de tuyaux.
Flèche télescopique	Flèche télescopique en acier à haute résistance à grains fins, à profil ovale, 1 élément de base et 5 éléments télescopiques. Tous les éléments télescopiques indépendamment les uns des autres. Système de télescopage séquentiel rapide «Telematik». Longueur de flèche: 41 ft – 190 ft.
Contrepoids	Contrepoids principal de 33100 lbs.
Installation électrique	Technique moderne de transmission de données par BUS de données. Courant continu 24 Volts, 2 batteries de 170 Ah chacune.

Equipment supplémentaire

Fléchette pliante	Longueur: 34 ft – 62 ft, montable sous un angle de 0°, 20° ou 40°. Vérin hydraulique pour le relevage de la fléchette pliante de 0° à 40° (en option).
Fléchette de montage	9 ft
Rallonge flèche télescopique	Élément en treillis de 23 ft, élevant le point d'articulation pour la fléchette pliante de 23 ft.
2ème mécanisme de levage	Pour l'utilisation du deuxième crochet, ou bien pour une utilisation avec fléchette pliante lorsque le câble de levage principal rest mouflé.
Contrepoids supplémentaire	17600 lbs pour un contrepoids total de 50700 lbs.
Pneumatiques	10 pneus. Taille: 20,5 R 25.
Entraînement 10 x 8	Essieu 1 est entraîné additionnellement.

Autres équipements supplémentaires sur demande.

Remarks referring to load charts

1. The tabulated lifting capacities do not exceed 85% of the tipping load.
2. The crane's structural steelwork is in accordance with DIN 15018, part 3. Design and construction of the crane comply with DIN 15018, part 2, and with F. E. M. regulations.
3. The 85% overturning limit values take into account wind force 5 = wind speed 20 mph.
4. Lifting capacities are given in kips.
5. The weight of the hook blocks and hooks must be deducted from the lifting capacities.
6. Working radii are measured from the slewing centreline.
7. The lifting capacities given for the telescopic boom only apply if the folding jib is taken off.
8. Lifting capacities are subject to modifications.
9. Lifting capacities above 139 kips / 190 kips only with additional pulley block / special equipment.

Remarques relatives aux tableaux des charges

1. Les forces de levage indiquées ne dépassent pas 85% de la charge de basculement.
2. La norme DIN 15018, 3ème partie est appliquée pour les charpentes. La construction de la grue est réalisée conformément à la norme DIN 15018, 2ème partie, et aux règles de la F. E. M.
3. A 85% de la charge de basculement, il a été tenu compte d'un vent de force 5 = vitesse de vent 20 mph.
4. Les forces de levage sont données en kips.
5. Les poids des moufles et crochets doit être soustrait des charges indiquées.
6. Les portées sont calculées à partir de l'axe de rotation.
7. Les forces indiquées pour la flèche télescopique s'entendent fléchette dépliée déposée.
8. Les forces de levage sont modifiables sans préavis.
9. Forces de levage plus de 139 kips / 190 kips seulement avec un moufle complémentaire / équipement supplémentaire.