

# GR-1300XL-4

130 US TON MAX. CRANE CAPACITY

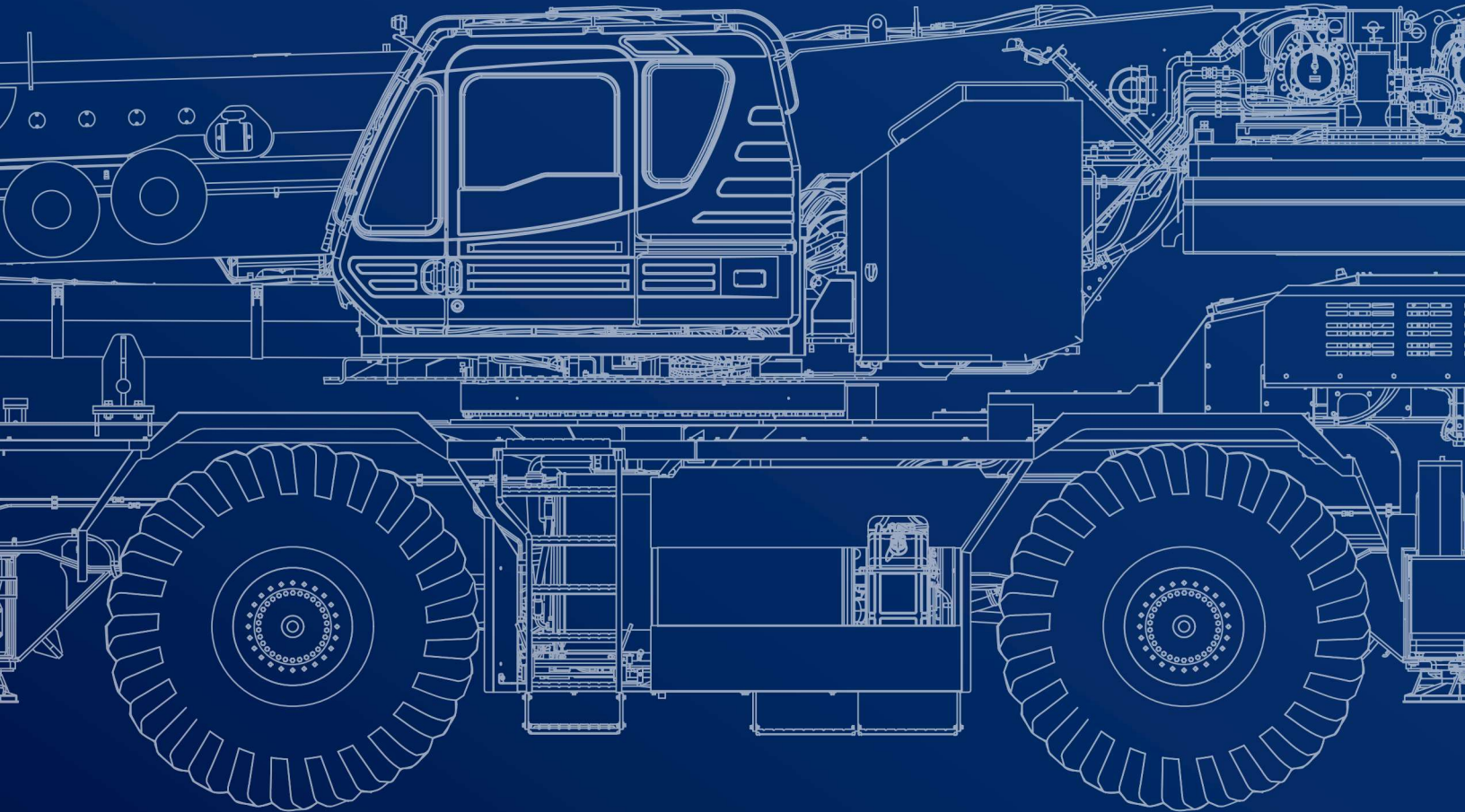

February 2023. Unless otherwise specified, all information in this brochure refers to a standard crane equipment, and it is intended as general information only. No liability is assumed. Errors reserved. Product specifications and prices are subject to changes without notice. The photographs and/or drawings in this brochure are for illustrative purposes only. For correct and safe crane operation, the original operating manual and lifting capacity charts are essential. Failure to follow the corresponding Operator's Manual when using our equipment or failure to otherwise act responsibly may result in property damage, serious injury or death. The sole warranty applicable with respect to our equipment is the standard warranty as per general terms and conditions of sales and service (ask your local Tadano dealer for details), and Tadano makes no other warranty, express or implied. All rights reserved. Any use of the trademarks, logos, brand names and model names used herein is prohibited.

© Tadano Ltd. 2023

# Contents

<b>Specifications</b>	<b>5</b>
Vehicle dimensions .....	6-7
General dimensions .....	7
<b>Off-road driving</b>	<b>9</b>
Axle weight distribution chart .....	10
Speeds and gradeability .....	10
Steering .....	10
<b>Operation</b>	<b>11</b>
Main boom .....	12
Slewing .....	12
Hoist .....	12
Outrigger cylinders .....	12
Hook blocks .....	12
Line speeds and pulls .....	13
Drum wire rope capacities .....	13
Drum dimensions .....	13
<b>MB:</b> Main boom.....	14-23
<b>FJ:</b> Folding swing-away jib.....	24-33
Notes to Lifting Capacity .....	34
Warning and Operating Instructions for on Rubber Lifting Capacities .....	35
Notes for Load Moment Indicator (AML-E2) .....	35
<b>Technical Description</b>	<b>37</b>
Crane specifications.....	38-39
Carrier specifications.....	39
Standard equipment.....	40-41
Optional equipment.....	41

# Key

	Counterweight		Rope diameter
	Lifting capacities on outriggers · 360°		Rope length
	Radius		Hook block
	Main boom		Number of lines
	Main boom length		Number of sheaves in hook block
	Folding swing-away jib		Line pulls available
	Free on wheels		Possible load of hook block
	Tires		Weight of hook block
	Hook block		Distance head sheave axle – hook ground
	Hoist		Max. outrigger load
	Travel speed		Length of stroke (support cylinders)
	Gradeability		Base machine
	Working speeds		Gross vehicle weight
	Rope		Weight on front axle
	Jib		Weight on rear axle
	Boom telescoping		Wire rope layer
	Boom elevation		Total wire rope
	Slewing		<b>Smart Chart:</b> Smart crane control system for main boom and rooster sheave operation enabling higher lifting capacities especially over outriggers. Enables safe use of the full capacity of the crane even in asymmetric outrigger configurations. Visualization of full working area in operator cabin. In-cab lift simulation.
	Max. line pull		



# SPECIFICATIONS

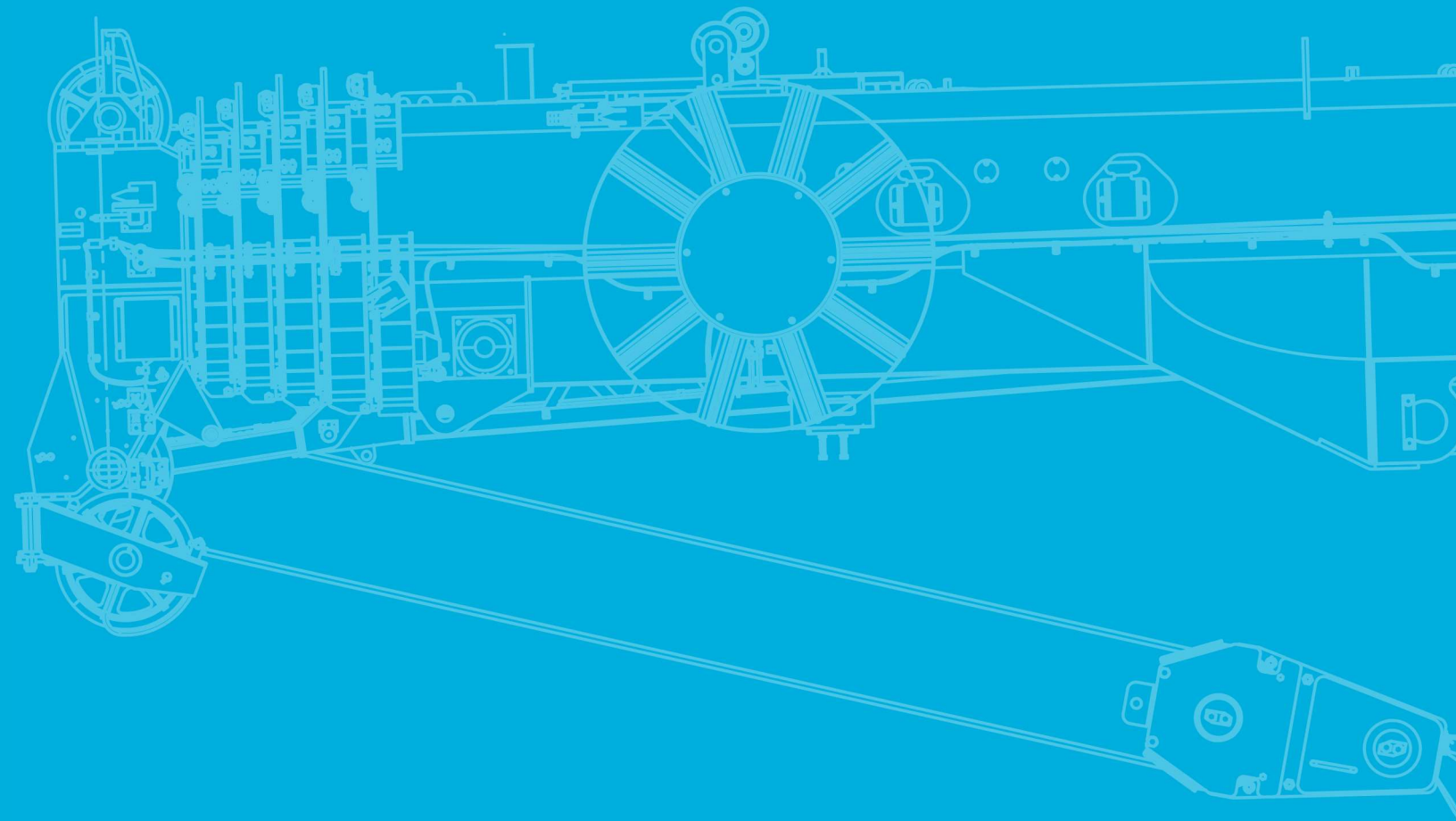

# Specifications

## Vehicle dimensions

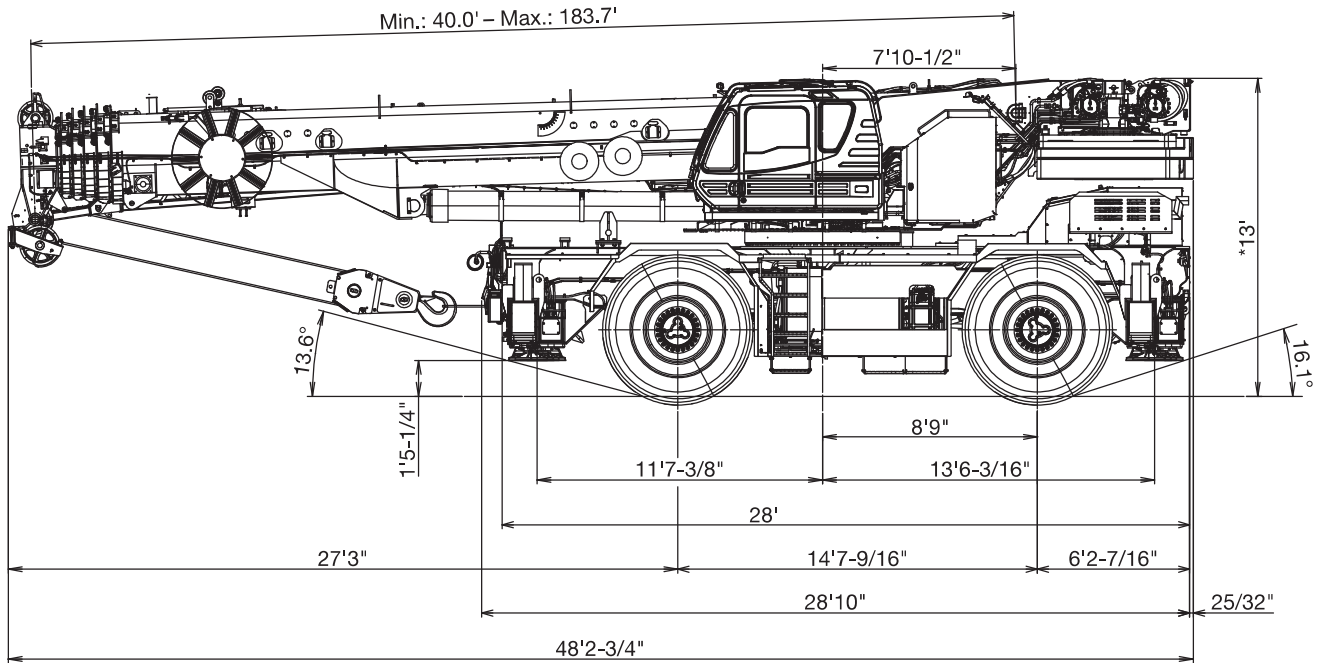

\* Overall height: when installed fall protection system on boom: 13' 2-5/8"

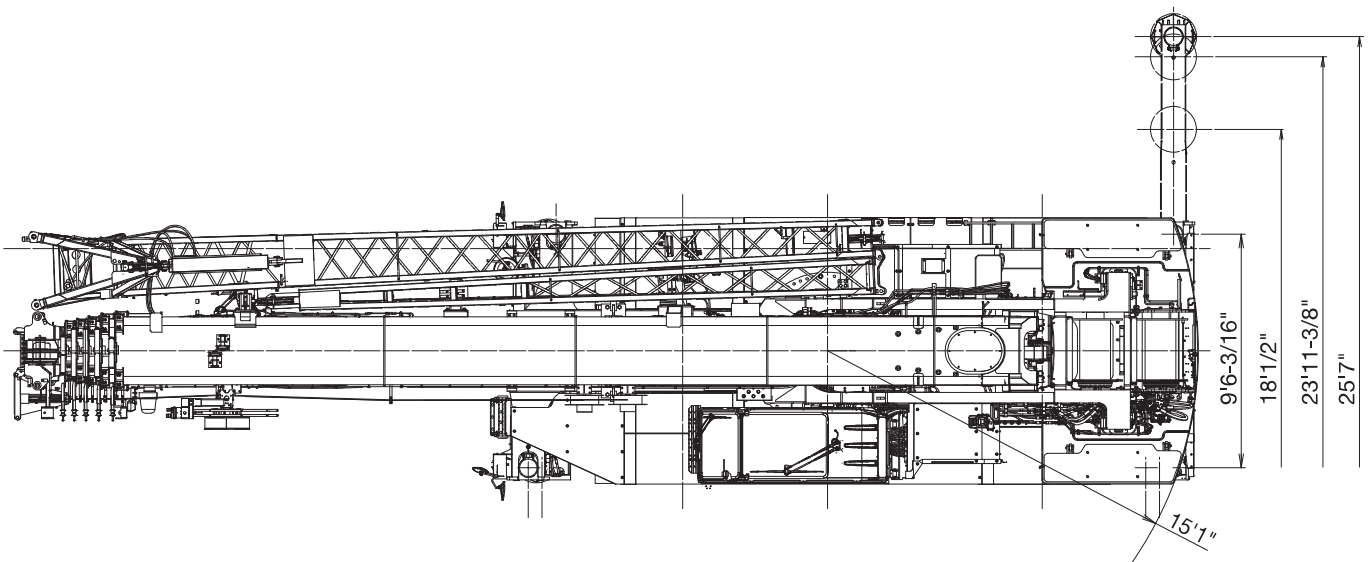

Dimension is with boom angle at -1.5 degree.

# Specifications

## Vehicle dimensions

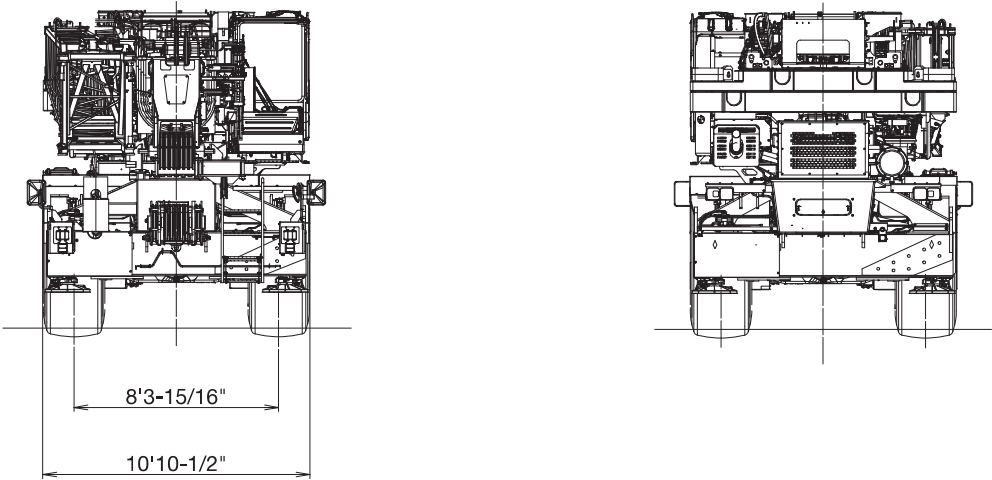

## General dimensions

Overall length	approx. 48' 2-3/4"
Overall width	approx. 10' 10-1/2"
Overall height*	approx. 13'
4 wheel steer	24' 7"
2 wheel steer	44'





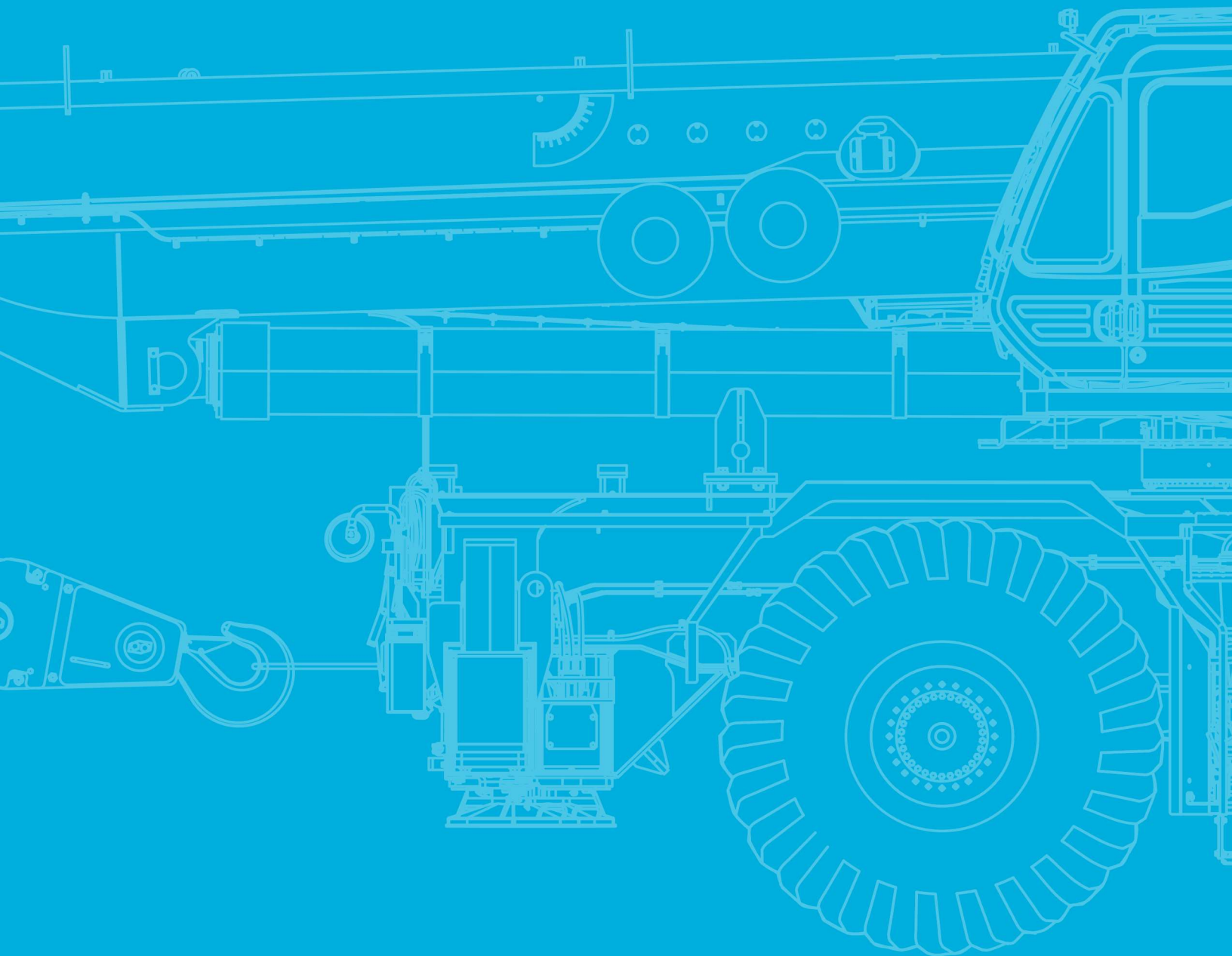

\* When installed fall protection system on boom: 13' 2-5/8"



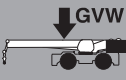
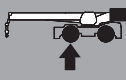
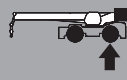



# TECHNICAL DATA FOR OFF-ROAD DRIVING



# Off-road driving

Axle weight distribution chart			
			
	158,100 lb	79,100 lb	79,000 lb
<b>Remove:</b>			
 100 ton	-1,800 lb	-3,280 lb	1,480 lb
 7.9 ton	-370 lb	-550 lb	180 lb
 Jib	-3,370 lb	-5,920 lb	2,550 lb
 43,500 lb	-43,500 lb	9,300 lb	-52,800 lb
Auxiliary winch and wire rope	-2,600 lb	740 lb	-3,340 lb

Speeds and gradeability	
	29.5-25 34PR
	57 % at stall Machine should be operated within the limit of engine crankcase design (30°: Cummins B6.7)
	12 mph

Steering	
	4 wheel steer
	2 wheel steer

# TECHNICAL DATA FOR OPERATION

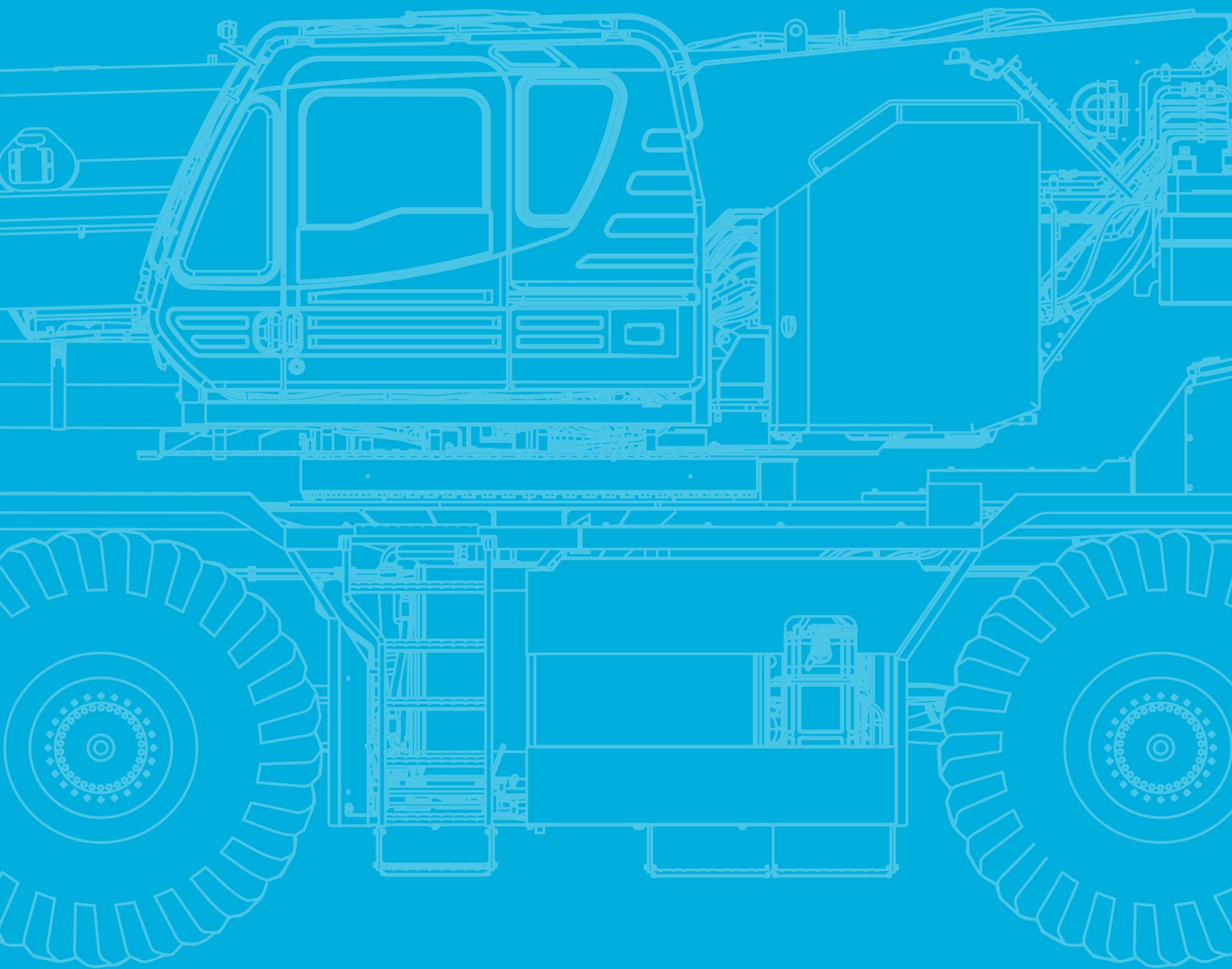



# Operation







## Main boom

	approx. 410 s (40.0 ft - 183.7 ft)		-1.5° - 81.5° approx. 28 s (20° - 60°)
---	------------------------------------	---	---



## Slewing

	1.3 min <sup>-1</sup>
---	-----------------------





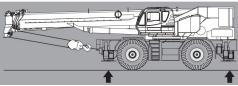

## Hoist

				
	476 ft/min	15,900 lb	3/4"	1050'
	676 ft/min	15,900 lb	3/4"	738'

## Outrigger cylinders

		
	159,800 lb	159,800 lb
	26.4"	26.4"



## Hook Blocks

					
7.9 ton	15,800 lb	—	1	370 lb	7.7 ft
100 ton	200,000 lb	7	14	1,800 lb	8.1 ft

# Operation

## Line speeds and pulls

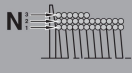
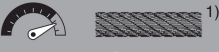
### Main or auxiliary winch - 15" drum

 N	 low   high		 low
	low	high	
1	253 ft/min.	354 ft/min.	21,800 lb
2	276 ft/min.	384 ft/min.	19,900 lb
3	299 ft/min.	413 ft/min.	18,200 lb
4	318 ft/min.	446 ft/min.	16,800 lb
5	341 ft/min.	476 ft/min.	15,600 lb
6	361 ft/min.	505 ft/min.	14,600 lb
7 <sup>3)</sup>	384 ft/min.	535 ft/min.	13,700 lb

Maximum permissible line pull wire strength. 15,900 lb with 7 x 35 class rope.



1) Line speed based only on hook block, not loaded.

2) Developed by machinery with each layer of wire rope, but not based on rope strength or other limitations in machinery or equipment.

3) Seventh layer of wire rope are not recommended for hoisting operations.

## Drum wire rope capacities

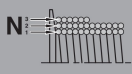
### Main and auxiliary drum grooved lagging 3/4" wire rope



 N		 Σ
1	147.0 ft	147.0 ft
2	159.4 ft	306.4 ft
3	172.2 ft	478.7 ft
4	184.7 ft	663.4 ft
5	197.2 ft	860.6 ft
6	209.6 ft	1070.2 ft
7	222.1 ft	1292.3 ft

## Drum dimensions

Root diameter	15"
Length	29-1/4"
Flange diameter	26-5/8"

# Operation

Fully extended – 360°

43,500 lb		25' 7" x 25' 5-1/2"										360°						
		40.0'*	40.0'	53.3'	53.3'	53.3'	66.6'	66.6'	66.6'	66.6'	79.9'	79.9'	79.9'	79.9'	93.2'	93.2'	93.2'	93.2'
ft	1,000 lb																	
8	260,000	200,000	77,200	143,300	143,300	77,200	77,200	143,300	143,300	-	-	-	-	-	-	-	-	-
10	244,400	200,000	77,200	143,300	143,300	77,000	77,200	143,300	143,300	70,200	77,200	143,300	77,200	-	-	-	-	-
12	220,900	200,000	77,200	143,300	143,300	71,800	77,200	143,300	143,300	65,800	77,200	143,300	77,200	55,100	77,200	105,700	77,200	77,200
15	192,800	172,500	77,200	143,300	143,300	65,000	77,200	143,300	143,300	59,900	77,200	138,500	77,200	50,400	77,200	93,900	77,200	77,200
20	143,700	135,000	77,200	135,400	124,400	56,000	77,200	133,100	123,400	51,800	77,200	117,500	77,200	43,700	77,200	78,900	77,200	77,200
25	111,400	109,500	72,700	109,900	108,400	49,200	68,900	109,700	107,700	45,500	70,500	102,000	77,200	38,400	74,800	67,900	77,200	77,200
30	89,900	89,900	65,600	90,500	91,500	43,800	61,600	90,200	92,000	40,500	62,300	90,000	77,200	34,100	67,100	59,400	77,200	77,200
35	-	-	60,000	71,200	72,500	39,300	55,600	70,800	73,000	36,400	55,700	72,000	71,500	30,500	60,500	52,700	74,000	74,000
40	-	-	55,800	56,100	57,300	35,600	50,800	55,800	57,900	33,000	50,400	57,100	60,000	27,600	55,200	47,300	59,000	59,000
45	-	-	-	-	-	32,700	46,800	45,200	47,200	30,200	46,000	46,500	49,300	25,200	50,600	42,800	48,300	48,300
50	-	-	-	-	-	30,200	42,700	37,400	39,300	27,800	42,400	38,700	41,300	23,100	42,900	37,900	40,500	40,500
55	-	-	-	-	-	28,300	36,500	31,500	33,300	25,800	37,000	32,700	35,100	21,300	36,800	31,900	34,500	34,500
60	-	-	-	-	-	-	-	-	-	24,100	32,100	27,900	30,300	19,800	31,800	27,100	29,600	29,600
65	-	-	-	-	-	-	-	-	-	22,700	28,200	24,100	26,300	18,500	27,800	23,300	25,600	25,600
70	-	-	-	-	-	-	-	-	-	21,600	24,900	21,000	23,100	17,300	24,500	20,100	22,400	22,400
75	-	-	-	-	-	-	-	-	-	-	-	-	-	16,300	21,800	17,400	19,700	19,700
80	-	-	-	-	-	-	-	-	-	-	-	-	-	15,500	19,500	15,200	17,400	17,400
	20	14	6	10	10	6	6	10	10	6	6	10	6	4	6	8	6	6
1)	77,800	77,800	71,000	67,500	70,500	59,700	69,900	65,000	68,600	59,700	68,300	66,100	65,300	55,100	66,400	66,100	62,800	62,800
2)	0°	0°	0°	0°	0°	0°	0°	0°	0°	0°	0°	0°	0°	0°	0°	0°	0°	0°
3)	1	1	1	9	10	1	2	9	10	1	2	10	11	1	2	10	11	11
4)	1	1	2	26	28	3	12	27	29	4	13	30	32	5	14	31	33	33

**Telescopic conditions (%)**

	1.	2.	3.	4.	5.	6.	7.	8.	9.	10.	11.	12.	13.	14.	15.	16.	17.	18.
1.	0	0	0	0	0	0	0	46	0	0	0	46	0	0	0	92	46	46
2.	0	0	0	46	0	0	0	46	46	0	0	46	46	0	46	46	46	46
3.	0	0	0	0	46	0	0	0	46	0	46	46	46	0	46	46	46	46
4.	0	0	0	0	0	0	46	0	0	46	46	0	46	92	46	0	46	46
5.	0	0	46	0	0	92	46	0	0	92	46	0	0	92	46	0	0	0

\* Over front with special equipment

- 1) Maximum capacity without boom pin
- 2) Minimum boom angle (°) for indicator length (no load)
- 3) Boom block
- 4) Boom number



**NOTE:**

The lifting capacity data stored in the LOAD MOMENT INDICATOR (AML-E2) is based on the standard number of parts of line listed in the chart.

# Operation

MB

Fully extended – 360°

43,500 lb		25' 7" x 25' 5-1/2"																360°	
		106.5'	106.5'	106.5'	106.5'	119.8'	119.8'	119.8'	133.0'	133.0'	133.0'	133.0'	146.3'	146.3'	146.3'	159.6'	159.6'	172.9'	183.7'
ft		1,000 lb																	
15		50,100	73,000	77,200	60,200	-	-	-	-	-	-	-	-	-	-	-	-	-	-
20		44,400	73,000	72,700	54,200	43,200	58,200	51,800	-	-	-	-	-	-	-	-	-	-	-
25		39,600	73,000	62,600	48,900	39,100	58,000	48,900	36,400	39,200	46,300	43,900	30,900	36,800	34,200	-	-	-	-
30		35,600	69,100	54,800	44,500	35,400	51,800	45,000	35,500	36,300	46,300	43,900	30,900	36,800	34,200	27,100	29,500	-	-
35		32,300	64,000	48,600	40,700	31,400	46,000	41,500	32,800	33,600	42,800	41,600	30,900	36,800	34,200	27,100	29,500	24,000	-
40		29,500	58,700	43,600	37,600	28,200	41,300	38,600	29,800	31,200	38,700	39,000	29,100	35,400	32,000	27,100	29,500	24,000	20,900
45		27,100	49,800	39,400	34,900	25,500	37,300	36,000	27,200	29,000	35,000	35,600	27,000	32,800	29,800	26,700	29,200	24,000	20,900
50		25,100	41,900	35,900	32,500	23,300	34,100	33,800	24,900	27,200	31,900	32,500	25,100	30,400	27,800	25,100	27,500	24,000	20,900
55		23,200	35,800	33,000	30,500	21,400	31,300	31,800	23,000	25,500	29,200	29,900	23,400	27,800	26,000	23,600	26,000	23,300	20,700
60		21,500	31,000	28,600	28,700	19,800	28,800	30,000	21,300	24,100	26,900	27,500	21,800	25,600	24,400	22,200	24,400	22,000	18,700
65		20,000	27,000	24,700	27,100	18,300	26,300	28,300	19,900	22,800	24,900	25,500	20,400	23,700	22,900	20,900	22,900	20,900	17,000
70		18,700	23,700	21,500	25,600	17,000	23,000	25,000	18,600	21,600	22,900	23,800	19,200	21,900	21,500	19,700	21,200	19,800	15,500
75		17,500	21,000	18,800	22,800	15,900	20,200	22,200	17,400	20,500	20,200	21,200	18,000	20,400	20,300	18,600	19,800	18,800	14,100
80		16,500	18,600	16,400	20,500	14,900	17,900	19,800	16,400	19,600	17,900	18,900	17,000	18,200	19,200	17,600	18,500	17,900	13,000
85		15,600	16,600	14,500	18,400	14,100	15,900	17,800	15,500	18,300	15,800	16,800	16,000	16,100	17,400	16,700	16,600	17,000	11,900
90		14,800	14,900	12,700	16,700	13,300	14,100	16,000	14,600	16,500	14,100	15,100	15,100	14,400	15,700	15,900	14,900	15,500	11,000
95		14,200	13,400	11,300	15,200	12,500	12,500	14,400	13,900	14,900	12,500	13,500	14,300	12,800	14,100	14,700	13,300	13,900	10,100
100		-	-	-	-	11,900	11,200	13,000	13,200	13,500	11,100	12,100	13,500	11,400	12,700	13,300	11,900	12,600	9,300
105		-	-	-	-	11,300	10,000	11,800	12,600	12,300	9,900	10,900	12,500	10,200	11,500	12,100	10,700	11,400	8,600
110		-	-	-	-	10,800	8,900	10,800	11,900	11,200	8,800	9,800	11,400	9,100	10,300	11,000	9,600	10,200	7,900
115		-	-	-	-	-	-	-	11,000	10,200	7,800	8,800	10,400	8,100	9,300	10,000	8,600	9,200	7,300
120		-	-	-	-	-	-	-	10,100	9,300	7,000	7,900	9,500	7,200	8,500	9,100	7,700	8,300	6,800
125		-	-	-	-	-	-	-	-	-	-	-	8,600	6,400	7,700	8,200	6,900	7,500	6,200
130		-	-	-	-	-	-	-	-	-	-	-	7,900	5,700	6,900	7,500	6,200	6,700	5,800
135		-	-	-	-	-	-	-	-	-	-	-	7,300	5,100	6,300	6,800	5,500	6,100	5,300
140		-	-	-	-	-	-	-	-	-	-	-	-	-	-	6,200	4,900	5,400	4,900
145		-	-	-	-	-	-	-	-	-	-	-	-	-	-	5,600	4,300	4,900	4,500
150		-	-	-	-	-	-	-	-	-	-	-	-	-	-	5,200	3,900	4,300	4,100
155		-	-	-	-	-	-	-	-	-	-	-	-	-	-	-	-	3,900	3,800
160		-	-	-	-	-	-	-	-	-	-	-	-	-	-	-	-	3,500	3,400
165		-	-	-	-	-	-	-	-	-	-	-	-	-	-	-	-	-	3,000
170		-	-	-	-	-	-	-	-	-	-	-	-	-	-	-	-	-	2,600
175		-	-	-	-	-	-	-	-	-	-	-	-	-	-	-	-	-	2,300
		4	6	6	6	4	4	4	4	4	4	4	4	4	4	4	4	4	4
1)		50,100	63,700	62,800	59,700	43,200	58,200	51,800	36,400	39,200	46,300	43,900	30,900	36,800	34,200	27,100	29,500	24,000	20,900
2)		0°	0°	0°	0°	0°	0°	0°	0°	0°	0°	0°	0°	0°	0°	13°	13°	13°	13°
3)		1	2	11	3	1	2	3	1	4	5	3	1	6	7	1	7	1	8
4)		6	15	34	17	7	16	18	8	20	21	19	9	22	23	10	24	11	25

### Telescopic conditions (%)

	1.	2.	3.	4.	5.	6.	7.	8.	9.	10.	11.	12.	13.	14.	15.	16.	17.	18.	19.
	0	46	92	0	0	92	46	0	46	92	92	0	92	46	46	92	92	100	
	0	46	46	46	0	46	46	46	46	92	46	92	92	92	92	92	92	92	100
	46	46	46	46	92	46	46	92	46	46	46	92	92	92	92	92	92	92	100
	92	46	46	46	92	46	46	92	92	46	46	92	46	92	92	92	92	92	100
	92	46	0	92	92	46	92	92	92	46	92	92	46	46	92	46	92	100	

- 1) Maximum capacity without boom pin
- 2) Minimum boom angle (°) for indicator length (no load)
- 3) Boom block
- 4) Boom number

### NOTE:

The lifting capacity data stored in the LOAD MOMENT INDICATOR (AML-E2) is based on the standard number of parts of line listed in the chart.

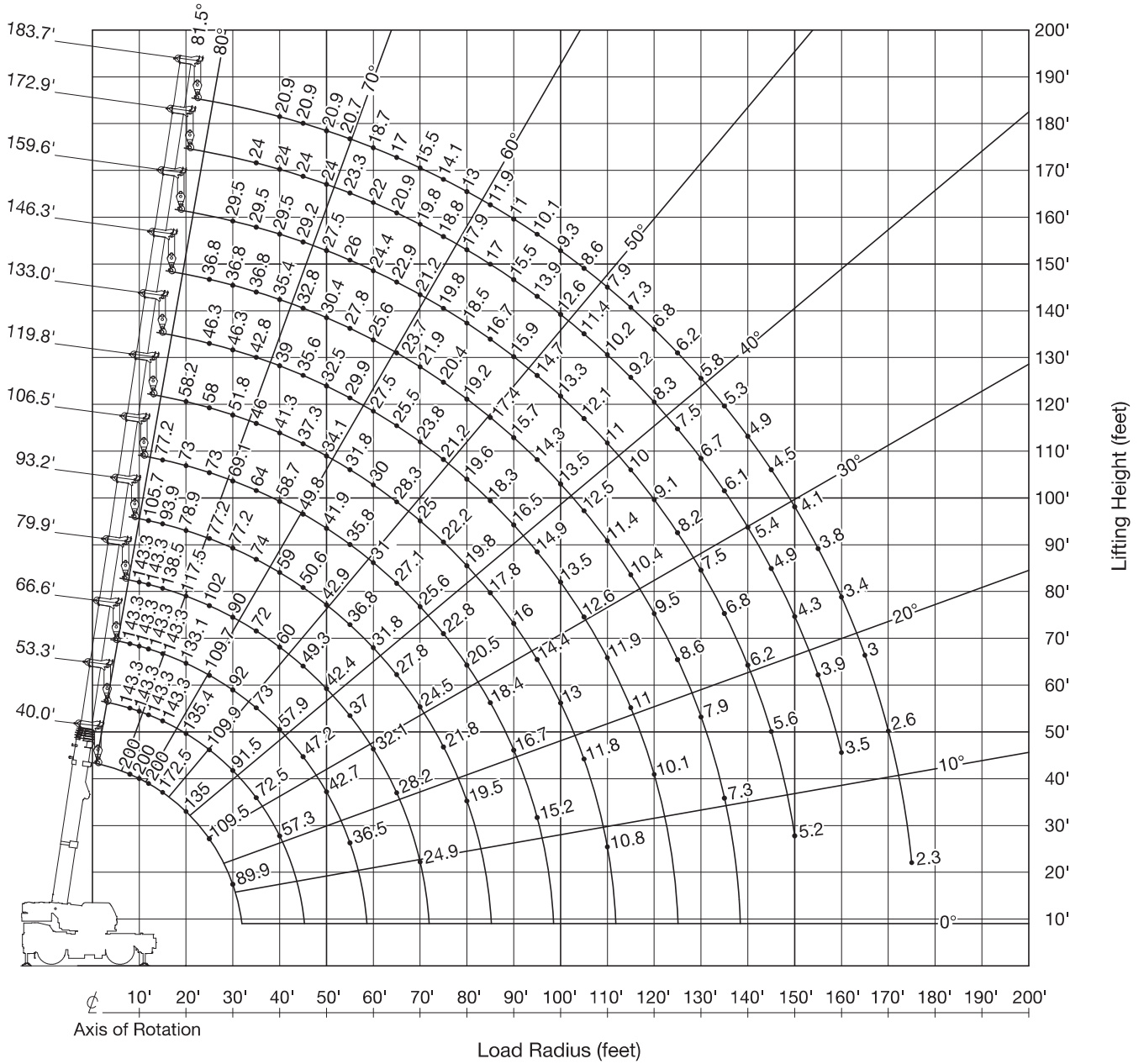

BOOM

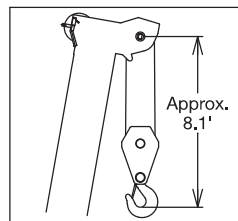

SINGLE TOP

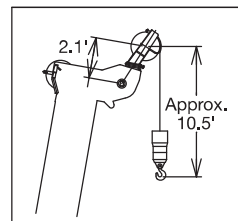

**NOTE:**

Boom geometry shown are for unloaded condition and machine standing level on firm supporting surface. Boom deflection and subsequent radius and boom angle change must be accounted for when applying load to hook.

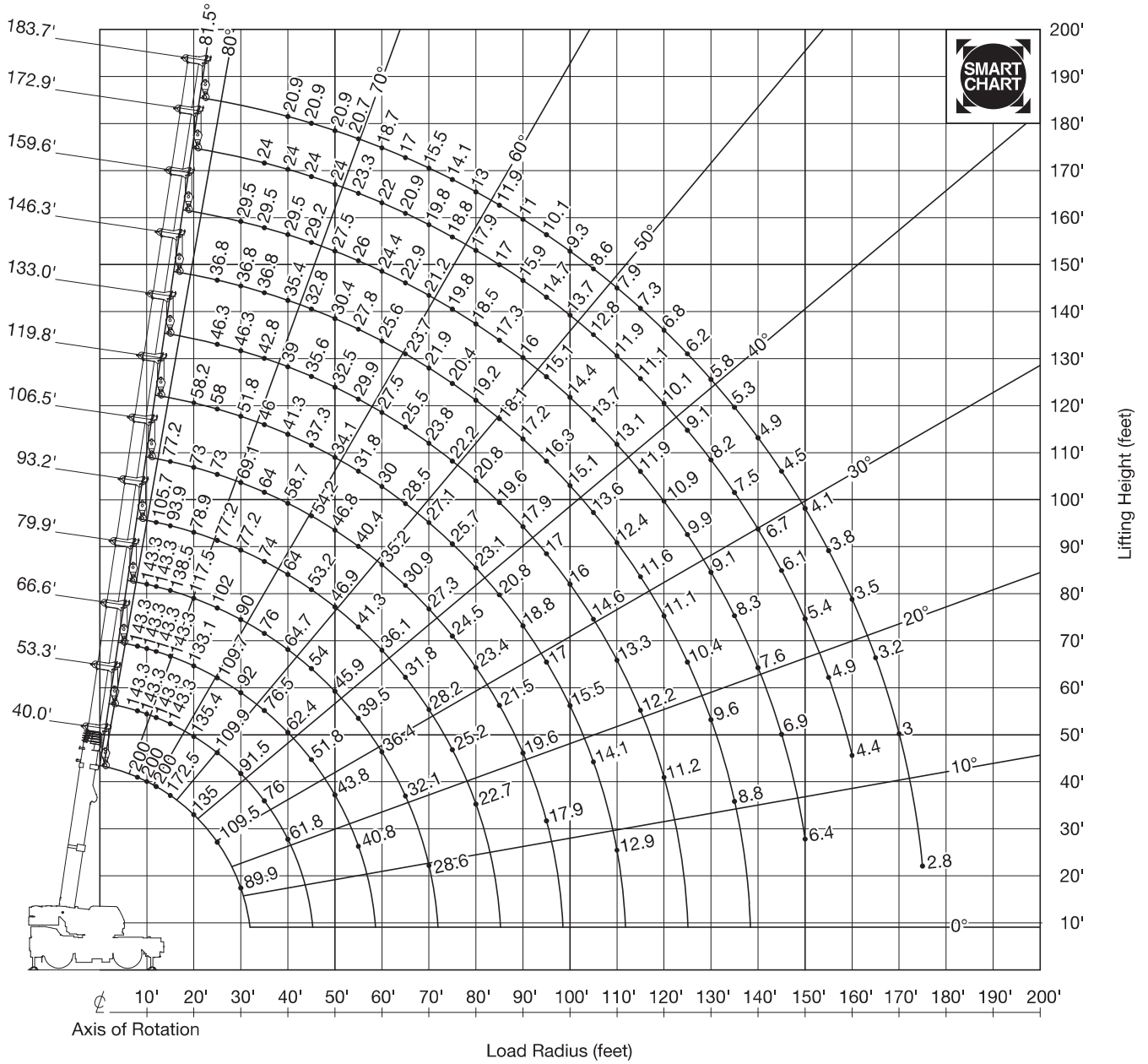

**NOTE:**

Boom geometry shown are for unloaded condition and machine standing level on firm supporting surface. Boom deflection and subsequent radius and boom angle change must be accounted for when applying load to hook.

## Fully extended – 360° – Smart Chart

43,500 lb		25' 7" x 25' 5-1/2"										360°						
		40.0*	40.0'	53.3'	53.3'	53.3'	66.6'	66.6'	66.6'	66.6'	79.9'	79.9'	79.9'	79.9'	93.2'	93.2'	93.2'	93.2'
ft	1,000 lb																	
8	260,000	200,000	77,200	143,300	143,300	77,200	77,200	143,300	143,300	-	-	-	-	-	-	-	-	-
10	244,400	200,000	77,200	143,300	143,300	77,000	77,200	143,300	143,300	70,200	77,200	143,300	77,200	-	-	-	-	-
12	220,900	200,000	77,200	143,300	143,300	71,800	77,200	143,300	143,300	65,800	77,200	143,300	77,200	55,100	77,200	105,700	77,200	77,200
15	192,800	172,500	77,200	143,300	143,300	65,000	77,200	143,300	143,300	59,900	77,200	138,500	77,200	50,400	77,200	93,900	77,200	77,200
20	143,700	135,000	77,200	135,400	124,400	56,000	77,200	133,100	123,400	51,800	77,200	117,500	77,200	43,700	77,200	78,900	77,200	77,200
25	111,400	109,500	72,700	109,900	108,400	49,200	68,900	109,700	107,700	45,500	70,500	102,000	77,200	38,400	74,800	67,900	77,200	77,200
30	89,900	89,900	65,600	90,500	91,500	43,800	61,600	90,200	92,000	40,500	62,300	90,000	77,200	34,100	67,100	59,400	77,200	77,200
35	-	-	60,000	74,800	76,000	39,300	55,600	74,500	76,500	36,400	55,700	76,000	71,500	30,500	60,500	52,700	74,000	74,000
40	-	-	55,800	60,500	61,800	35,600	50,800	60,200	62,400	33,000	50,400	61,700	64,700	27,600	55,200	47,300	64,000	64,000
45	-	-	-	-	-	32,700	46,800	49,700	51,800	30,200	46,000	51,100	54,000	25,200	50,600	42,800	53,200	53,200
50	-	-	-	-	-	30,200	43,500	41,700	43,800	27,800	42,400	43,100	45,900	23,100	46,900	39,100	45,200	45,200
55	-	-	-	-	-	28,300	40,800	35,500	37,600	25,800	39,300	36,900	39,500	21,300	41,300	35,900	38,800	38,800
60	-	-	-	-	-	-	-	-	-	24,100	36,400	31,800	34,400	19,800	36,100	31,000	33,600	33,600
65	-	-	-	-	-	-	-	-	-	22,700	32,100	27,700	30,200	18,500	31,800	26,800	29,400	29,400
70	-	-	-	-	-	-	-	-	-	21,600	28,600	24,300	26,700	17,300	28,200	23,300	25,800	25,800
75	-	-	-	-	-	-	-	-	-	-	-	-	-	16,300	25,200	20,400	22,900	22,900
80	-	-	-	-	-	-	-	-	-	-	-	-	-	15,500	22,700	17,900	20,300	20,300
	20	14	6	10	10	6	6	10	10	6	6	10	6	4	6	8	6	6
1)	77,800	77,800	71,000	67,500	70,500	59,700	69,900	65,000	68,600	59,700	68,300	66,100	65,300	55,100	66,400	66,100	62,800	62,800
2)	0°	0°	0°	0°	0°	0°	0°	0°	0°	0°	0°	0°	0°	0°	0°	0°	0°	0°
3)	1	1	1	9	10	1	2	9	10	1	2	10	11	1	2	10	11	11
4)	1	1	2	26	28	3	12	27	29	4	13	30	32	5	14	31	33	33

### Telescopic conditions (%)

	1.	2.	3.	4.	5.	6.	7.	8.	9.	10.	11.	12.	13.	14.	15.	16.	17.	18.
	0	0	0	0	0	0	0	46	0	0	0	46	0	0	0	92	46	46
	0	0	0	46	0	0	0	46	46	0	0	46	46	0	46	46	46	46
	0	0	0	0	46	0	0	0	46	0	46	46	46	0	46	46	46	46
	0	0	0	0	0	0	46	0	0	46	0	46	0	46	92	46	0	46
	0	0	46	0	0	92	46	0	0	92	46	0	0	92	46	0	0	0

\* Over front with special equipment

- 1) Maximum capacity without boom pin
- 2) Minimum boom angle (°) for indicator length (no load)
- 3) Boom block
- 4) Boom number



Smart Chart

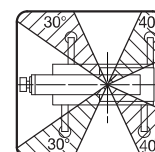

### NOTE:

The lifting capacity data stored in the LOAD MOMENT INDICATOR (AML-E2) is based on the standard number of parts of line listed in the chart.



## Fully extended – 360° – Smart Chart

43,500 lb		25' 7" x 25' 5-1/2"																360°	
106.5'		106.5'	106.5'	106.5'	119.8'	119.8'	119.8'	133.0'	133.0'	133.0'	133.0'	146.3'	146.3'	146.3'	159.6'	159.6'	172.9'	183.7'	
ft	1,000 lb																		
15	50,100	73,000	77,200	60,200	-	-	-	-	-	-	-	-	-	-	-	-	-	-	-
20	44,400	73,000	72,700	54,200	43,200	58,200	51,800	-	-	-	-	-	-	-	-	-	-	-	-
25	39,600	73,000	62,600	48,900	39,100	58,000	48,900	36,400	39,200	46,300	43,900	30,900	36,800	34,200	-	-	-	-	-
30	35,600	69,100	54,800	44,500	35,400	51,800	45,000	35,500	36,300	46,300	43,900	30,900	36,800	34,200	27,100	29,500	-	-	-
35	32,300	64,000	48,600	40,700	31,400	46,000	41,500	32,800	33,600	42,800	41,600	30,900	36,800	34,200	27,100	29,500	24,000	-	-
40	29,500	58,700	43,600	37,600	28,200	41,300	38,600	29,800	31,200	38,700	39,000	29,100	35,400	32,000	27,100	29,500	24,000	20,900	-
45	27,100	54,200	39,400	34,900	25,500	37,300	36,000	27,200	29,000	35,000	35,600	27,000	32,800	29,800	26,700	29,200	24,000	20,900	-
50	25,100	46,800	35,900	32,500	23,300	34,100	33,800	24,900	27,200	31,900	32,500	25,100	30,400	27,800	25,100	27,500	24,000	20,900	-
55	23,200	40,400	33,000	30,500	21,400	31,300	31,800	23,000	25,500	29,200	29,900	23,400	27,800	26,000	23,600	26,000	23,300	20,700	-
60	21,500	35,200	30,400	28,700	19,800	28,800	30,000	21,300	24,100	26,900	27,500	21,800	25,600	24,400	22,200	24,400	22,000	18,700	-
65	20,000	30,900	28,200	27,100	18,300	26,700	28,500	19,900	22,800	24,900	25,500	20,400	23,700	22,900	20,900	22,900	20,900	17,000	-
70	18,700	27,300	24,800	25,700	17,000	24,900	27,100	18,600	21,600	23,100	23,800	19,200	21,900	21,500	19,700	21,200	19,800	15,500	-
75	17,500	24,300	21,900	24,500	15,900	23,200	25,700	17,400	20,500	21,500	22,200	18,000	20,400	20,300	18,600	19,800	18,800	14,100	-
80	16,500	21,700	19,300	23,400	14,900	20,900	23,100	16,400	19,600	20,100	20,800	17,000	19,100	19,200	17,600	18,500	17,900	13,000	-
85	15,600	19,500	17,100	21,500	14,100	18,600	20,800	15,500	18,700	18,600	19,600	16,000	17,800	18,100	16,700	17,300	17,000	11,900	-
90	14,800	17,500	15,100	19,600	13,300	16,600	18,800	14,600	17,900	16,600	17,700	15,100	16,600	17,200	15,900	16,000	15,900	11,000	-
95	14,200	15,900	13,500	17,900	12,500	14,900	17,000	13,900	17,000	14,900	16,000	14,300	15,200	16,300	15,100	14,900	14,700	10,100	-
100	-	-	-	-	11,900	13,400	15,500	13,200	16,000	13,300	14,400	13,500	13,600	15,100	14,400	13,800	13,700	9,300	-
105	-	-	-	-	11,300	12,000	14,100	12,600	14,600	11,900	13,000	12,900	12,300	13,600	13,700	12,800	12,800	8,600	-
110	-	-	-	-	10,800	10,800	12,900	12,000	13,300	10,700	11,800	12,200	11,000	12,400	13,100	11,600	11,900	7,900	-
115	-	-	-	-	-	-	-	11,500	12,200	9,500	10,600	11,600	9,900	11,200	11,900	10,400	11,100	7,300	-
120	-	-	-	-	-	-	-	11,100	11,200	8,600	9,600	11,100	8,800	10,200	10,900	9,400	10,100	6,800	-
125	-	-	-	-	-	-	-	-	-	-	-	10,400	7,900	9,300	9,900	8,400	9,100	6,200	-
130	-	-	-	-	-	-	-	-	-	-	-	9,600	7,100	8,400	9,100	7,600	8,200	5,800	-
135	-	-	-	-	-	-	-	-	-	-	-	8,800	6,300	7,700	8,300	6,800	7,500	5,300	-
140	-	-	-	-	-	-	-	-	-	-	-	-	-	-	7,600	6,100	6,700	4,900	-
145	-	-	-	-	-	-	-	-	-	-	-	-	-	-	6,900	5,400	6,100	4,500	-
150	-	-	-	-	-	-	-	-	-	-	-	-	-	-	6,400	4,900	5,400	4,100	-
155	-	-	-	-	-	-	-	-	-	-	-	-	-	-	-	4,900	3,800	3,500	-
160	-	-	-	-	-	-	-	-	-	-	-	-	-	-	-	4,400	3,500	3,200	-
165	-	-	-	-	-	-	-	-	-	-	-	-	-	-	-	-	3,200	3,000	-
170	-	-	-	-	-	-	-	-	-	-	-	-	-	-	-	-	3,000	2,800	-
175	-	-	-	-	-	-	-	-	-	-	-	-	-	-	-	-	-	2,800	-
	4	6	6	6	4	4	4	4	4	4	4	4	4	4	4	4	4	4	4
1)	50,100	63,700	62,800	59,700	43,200	58,200	51,800	36,400	39,200	46,300	43,900	30,900	36,800	34,200	27,100	29,500	24,000	20,900	-
2)	0°	0°	0°	0°	0°	0°	0°	0°	0°	0°	0°	0°	0°	0°	13°	13°	13°	13°	-
3)	1	2	11	3	1	2	3	1	4	5	3	1	6	7	1	7	1	8	-
4)	6	15	34	17	7	16	18	8	20	21	19	9	22	23	10	24	11	25	-

### Telescopic conditions (%)

1.	0	46	92	0	0	92	46	0	46	92	92	0	92	46	46	92	92	100	-	
2.	0	46	46	46	0	46	46	46	46	92	46	92	92	92	92	92	92	92	100	-
3.	46	46	46	46	92	46	46	92	46	46	46	92	92	92	92	92	92	92	100	-
4.	92	46	46	46	92	46	46	92	92	46	46	92	46	92	92	92	92	92	100	-
5.	92	46	0	92	92	46	92	92	92	46	92	92	46	46	92	46	92	92	100	-

- 1) Maximum capacity without boom pin
- 2) Minimum boom angle (°) for indicator length (no load)
- 3) Boom block
- 4) Boom number

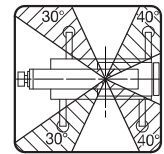
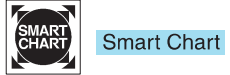

### NOTE:

The lifting capacity data stored in the LOAD MOMENT INDICATOR (AML-E2) is based on the standard number of parts of line listed in the chart.

# Operation

MB

## On rubber stationary

43,500 lb		0°*				
ft	1,000 lb					
8	66,000	66,000	66,000	-	-	
10	66,000	66,000	66,000	66,000	-	
12	66,000	66,000	66,000	62,000	51,300	
15	58,100	60,300	61,200	56,800	47,300	
20	44,800	47,100	48,300	49,400	41,400	
25	35,400	37,900	39,300	40,400	36,500	
30	28,400	31,000	32,400	33,600	32,500	
35	-	25,700	27,100	28,500	28,500	
40	-	21,500	23,000	24,300	24,400	
45	-	-	19,600	20,900	21,100	
50	-	-	16,800	18,100	18,300	
55	-	-	14,200	15,500	15,600	
60	-	-	-	13,300	13,400	
65	-	-	-	11,400	11,600	
70	-	-	-	9,900	10,100	
75	-	-	-	-	8,800	
80	-	-	-	-	7,700	
	6	6	6	6	4	
1)	0°	0°	0°	0°	0°	
2)	1	1	1	1	1	
3)	1	2	3	4	5	

43,500 lb		360°				
ft	1,000 lb					
8	-	-	-	-	-	
10	-	-	-	-	-	
12	-	-	-	-	-	
15	-	-	-	-	-	
20	-	-	-	-	-	
25	22,000	-	-	-	-	
30	16,100	19,100	-	-	-	
35	-	14,300	15,900	-	-	
40	-	10,900	12,400	-	-	
45	-	-	9,700	11,000	11,200	
50	-	-	7,600	8,900	9,100	
55	-	-	-	7,200	7,400	
60	-	-	-	5,800	6,000	
65	-	-	-	-	4,800	
70	-	-	-	-	3,800	
75	-	-	-	-	-	
80	-	-	-	-	-	
	4	4	4	4	4	
1)	0°	0°	30°	34°	36°	
2)	1	1	1	1	1	
3)	1	2	3	4	5	

### Telescopic conditions (%)

	1.	2.	3.	4.	5.
	0	0	0	0	0
	0	0	0	0	0
	0	0	0	0	0
	0	0	0	46	92
	0	46	92	92	92

### Telescopic conditions (%)

	1.	2.	3.	4.	5.
	0	0	0	0	0
	0	0	0	0	0
	0	0	0	0	0
	0	0	0	46	92
	0	46	92	92	92

- 1) Minimum boom angle (°) for indicator length (no load)
- 2) Boom block
- 3) Boom number

### NOTE:

The lifting capacity data stored in the LOAD MOMENT INDICATOR (AML-E2) is based on the standard number of parts of line listed in the chart.

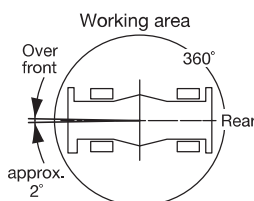

# Operation

MB

## On rubber creep

43,500 lb		0° *				
ft	40.0'	53.3'	66.6'	79.9'	93.2'	
	1,000 lb					
8	55,000	55,000	55,000	-	-	
10	55,000	55,000	55,000	55,000	-	
12	49,400	51,600	52,900	54,000	51,300	
15	41,000	43,300	44,700	45,800	46,000	
20	30,700	33,100	34,500	35,800	36,000	
25	23,500	26,000	27,500	28,800	29,000	
30	18,200	20,700	22,200	23,500	23,800	
35	-	16,600	18,100	19,500	19,700	
40	-	13,400	14,900	16,300	16,500	
45	-	-	12,300	13,700	13,900	
50	-	-	10,100	11,500	11,700	
55	-	-	8,300	9,700	9,900	
60	-	-	-	8,100	8,400	
65	-	-	-	6,800	7,000	
70	-	-	-	5,700	5,900	
75	-	-	-	-	4,900	
80	-	-	-	-	4,000	
	4	4	4	4	4	
1)	0°	0°	0°	0°	0°	
2)	1	1	1	1	1	
3)	1	2	3	4	5	

## Telescopic conditions (%)

	1.	0	0	0	0	0
	2.	0	0	0	0	0
	3.	0	0	0	0	0
	4.	0	0	0	46	92
	5.	0	46	92	92	92

- 1) Minimum boom angle (°) for indicator length (no load)
- 2) Boom block
- 3) Boom number

### NOTE:

The lifting capacity data stored in the LOAD MOMENT INDICATOR (AML-E2) is based on the standard number of parts of line listed in the chart.

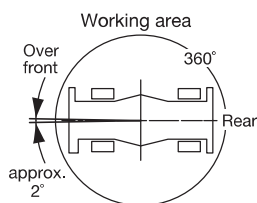

## On rubber stationary

0 lb		0°*				
ft	1,000 lb					
8	44,000	44,000	44,000	-	-	
10	44,000	44,000	44,000	44,000	-	
12	41,900	44,000	44,000	44,000	44,000	
15	34,400	36,700	37,700	38,800	38,900	
20	25,300	27,700	29,000	30,100	30,200	
25	15,600	19,000	20,900	22,700	23,100	
30	9,400	12,600	14,400	16,100	16,400	
35	-	8,400	10,200	11,700	12,100	
40	-	5,500	7,200	8,700	9,000	
45	-	-	5,000	6,400	6,700	
50	-	-	3,300	4,700	5,000	
55	-	-	-	3,300	3,600	
60	-	-	-	2,200	2,400	
	4	4	4	4	4	
1)	0°	28°	30°	31°	44°	
2)	1	1	1	1	1	
3)	1	2	3	4	5	

### Telescopic conditions (%)

	1.	0	0	0	0	0
	2.	0	0	0	0	0
	3.	0	0	0	0	0
	4.	0	0	0	46	92
	5.	0	46	92	92	92

- 1) Minimum boom angle (°) for indicator length (no load)
- 2) Boom block
- 3) Boom number

### NOTE:

The lifting capacity data stored in the LOAD MOMENT INDICATOR (AML-E2) is based on the standard number of parts of line listed in the chart.

0 lb		360°				
ft	1,000 lb					
8	33,000	33,000	33,000	-	-	
10	33,000	33,000	33,000	33,000	-	
12	27,000	30,900	33,000	33,000	33,000	
15	16,400	19,800	22,000	23,700	24,100	
20	7,200	10,200	12,100	13,700	14,100	
25	2,200	5,200	6,900	8,400	8,800	
30	-	2,000	3,700	5,100	5,400	
35	-	-	-	2,900	3,200	
40	-	-	-	-	-	
45	-	-	-	-	-	
50	-	-	-	-	-	
55	-	-	-	-	-	
60	-	-	-	-	-	
	4	4	4	4	4	
1)	37°	47°	58°	59°	64°	
2)	1	1	1	1	1	
3)	1	2	3	4	5	

### Telescopic conditions (%)

	1.	0	0	0	0	0
	2.	0	0	0	0	0
	3.	0	0	0	0	0
	4.	0	0	0	46	92
	5.	0	46	92	92	92

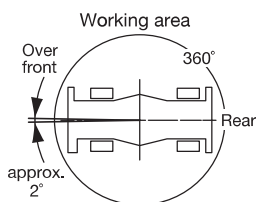

# Operation

## On rubber creep

0 lb		0°*				
	40.0'	53.3'	66.6'	79.9'	93.2'	
ft	1,000 lb					
8	44,000	44,000	44,000	-	-	
10	44,000	44,000	44,000	44,000	-	
12	41,900	44,000	44,000	44,000	44,000	
15	34,400	36,700	37,700	38,800	38,900	
20	25,300	27,700	29,000	30,100	30,200	
25	15,600	19,000	20,900	22,700	23,100	
30	9,400	12,600	14,400	16,100	16,400	
35	-	8,400	10,200	11,700	12,100	
40	-	5,500	7,200	8,700	9,000	
45	-	-	5,000	6,400	6,700	
50	-	-	3,300	4,700	5,000	
55	-	-	-	3,300	3,600	
60	-	-	-	2,200	2,400	
	4	4	4	4	4	
1)	0°	28°	30°	31°	44°	
2)	1	1	1	1	1	
3)	1	2	3	4	5	

## Telescopic conditions (%)

1.	0	0	0	0	0
2.	0	0	0	0	0
3.	0	0	0	0	0
4.	0	0	0	46	92
5.	0	46	92	92	92

- 1) Minimum boom angle (°) for indicator length (no load)
- 2) Boom block
- 3) Boom number

### NOTE:

The lifting capacity data stored in the LOAD MOMENT INDICATOR (AML-E2) is based on the standard number of parts of line listed in the chart.

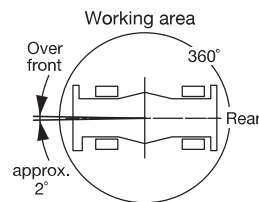

# Operation

FJ

Fully extended – 360°

43,500 lb				360°			
25' 7" x 25' 5-1/2"				360°			
183.7' + 33.8'				172.9' + 33.8'			
5° 20° 40°				5° 20° 40°			
ft	1,000 lb			ft	1,000 lb		
50	-	-	-	50	12,300	-	-
55	11,000	11,000	-	55	12,300	12,300	-
60	11,000	11,000	-	60	12,300	12,300	-
65	11,000	11,000	11,000	65	12,300	12,300	12,300
70	11,000	11,000	11,000	70	12,300	12,300	12,300
75	11,000	11,000	11,000	75	12,300	12,300	12,300
80	11,000	11,000	11,000	80	12,300	12,300	12,100
85	11,000	11,000	11,000	85	12,300	12,200	11,700
90	11,000	11,000	10,800	90	12,300	11,700	11,200
95	10,200	10,600	10,400	95	11,900	11,300	10,900
100	9,300	9,700	10,100	100	11,500	10,900	10,500
105	8,600	8,900	9,300	105	11,100	10,500	10,100
110	7,800	8,200	8,600	110	10,400	10,200	9,800
115	7,200	7,500	7,900	115	9,400	9,800	9,500
120	6,600	6,900	7,200	120	8,600	9,000	9,200
125	6,000	6,400	6,700	125	7,800	8,200	8,600
130	5,500	5,800	6,100	130	7,100	7,500	7,900
135	5,000	5,400	5,600	135	6,400	6,800	7,100
140	4,600	4,900	5,100	140	5,800	6,100	6,500
145	4,200	4,500	4,700	145	5,200	5,500	5,800
150	3,800	4,100	4,300	150	4,700	5,000	5,200
155	3,400	3,700	3,900	155	4,100	4,400	4,700
160	3,100	3,300	3,500	160	3,600	3,900	4,100
165	2,800	3,000	3,100	165	3,200	3,400	-
170	2,500	2,600	-	170	2,800	3,000	-
175	2,200	2,400	-	175	2,400	2,600	-
180	1,800	2,000	-	180	2,000	2,200	-
185	1,400	1,600	-	185	1,600	1,800	-
190	-	-	-	190	1,300	-	-
195	-	-	-	195	1,000	-	-

# Operation

Fully extended – 360°

43,500 lb				360°			
25' 7" x 25' 5-1/2"				360°			
159.6' + 33.8'				106.5' + 33.8'			
	5°	20°	40°		5°	20°	40°
ft	1,000 lb			ft	1,000 lb		
25	-	-	-	25	29,500	-	-
30	-	-	-	30	29,500	24,000	-
35	-	-	-	35	28,800	22,400	-
40	-	-	-	40	27,500	21,100	15,900
45	14,800	-	-	45	26,300	19,900	15,300
50	14,800	14,800	-	50	24,900	18,800	14,800
55	14,800	14,800	-	55	23,200	17,900	14,300
60	14,800	14,800	14,500	60	21,700	17,000	13,800
65	14,800	14,800	14,100	65	20,400	16,300	13,400
70	14,800	14,800	13,700	70	19,300	15,600	13,100
75	14,800	14,800	13,400	75	18,300	15,000	12,700
80	14,800	14,700	13,100	80	17,400	14,500	12,400
85	14,700	14,100	12,800	85	16,600	14,000	12,100
90	14,000	13,600	12,500	90	15,600	13,500	11,900
95	13,300	13,100	12,200	95	14,200	13,100	11,700
100	12,200	12,500	12,000	100	12,900	12,700	11,500
105	11,100	11,700	11,800	105	11,800	12,200	11,400
110	10,000	10,600	11,100	110	10,700	11,100	-
115	9,100	9,600	10,100	115	9,800	10,100	-
120	8,200	8,700	9,100	120	9,000	9,200	-
125	7,400	7,900	8,300	125	8,200	8,400	-
130	6,700	7,100	7,500	130	7,500	-	-
135	6,100	6,400	6,700	135	-	-	-
140	5,400	5,800	6,100	140	-	-	-
145	4,800	5,200	5,400	145	-	-	-
150	4,300	4,600	4,800	150	-	-	-
155	3,700	4,000	-	155	-	-	-
160	3,300	3,500	-	160	-	-	-
165	2,800	3,000	-	165	-	-	-
170	2,400	2,600	-	170	-	-	-
175	2,000	2,100	-	175	-	-	-
180	1,700	-	-	180	-	-	-
185	1,300	-	-	185	-	-	-



# Operation

Fully extended – 360°

43,500 lb				360°			
25' 7" x 25' 5-1/2"				360°			
183.7' + 59.1'				172.9' + 59.1'			
5° 20° 40°				5° 20° 40°			
1,000 lb				1,000 lb			
ft				ft			
55	-	-	-	55	7,900	-	-
60	7,500	-	-	60	7,900	-	-
65	7,500	-	-	65	7,900	-	-
70	7,500	-	-	70	7,900	7,900	-
75	7,500	7,500	-	75	7,900	7,900	-
80	7,500	7,500	-	80	7,900	7,900	-
85	7,500	7,500	-	85	7,900	7,900	7,100
90	7,500	7,500	6,800	90	7,900	7,900	6,900
95	7,500	7,500	6,700	95	7,900	7,900	6,800
100	7,500	7,500	6,600	100	7,900	7,700	6,700
105	7,500	7,400	6,500	105	7,900	7,600	6,500
110	7,500	7,300	6,300	110	7,900	7,400	6,400
115	7,500	7,100	6,200	115	7,900	7,200	6,300
120	7,000	7,000	6,200	120	7,900	7,100	6,200
125	6,400	6,800	6,000	125	7,700	6,900	6,000
130	5,900	6,500	5,900	130	7,400	6,800	5,900
135	5,400	6,000	5,800	135	7,000	6,600	5,800
140	4,900	5,500	5,700	140	6,300	6,500	5,700
145	4,500	5,000	5,500	145	5,700	6,400	5,600
150	4,100	4,600	5,000	150	5,200	5,900	5,600
155	3,700	4,200	4,600	155	4,600	5,300	5,500
160	3,400	3,800	4,200	160	4,100	4,800	5,300
165	3,000	3,500	3,800	165	3,700	4,300	4,800
170	2,700	3,100	3,500	170	3,300	3,800	4,300
175	2,400	2,800	3,100	175	2,900	3,400	3,800
180	2,200	2,500	2,800	180	2,500	2,900	3,300
185	1,800	2,200	2,500	185	2,100	2,500	2,900
190	-	1,900	2,200	190	1,800	2,200	-
195	-	-	-	195	1,500	1,800	-
200	-	-	-	200	-	1,500	-

# Operation

Fully extended – 360°

43,500 lb				360°			
25' 7" x 25' 5-1/2"				360°			
159.6' + 59.1'				106.5' + 59.1'			
ft	5°	20°	40°	ft	5°	20°	40°
1,000 lb				1,000 lb			
30	-	-	-	30	12,600	-	-
35	-	-	-	35	12,600	-	-
40	-	-	-	40	12,600	-	-
45	-	-	-	45	12,600	11,900	-
50	9,000	-	-	50	12,600	11,400	-
55	9,000	-	-	55	12,600	11,000	-
60	9,000	-	-	60	12,600	10,500	8,200
65	9,000	9,000	-	65	12,200	10,000	7,900
70	9,000	9,000	-	70	11,700	9,500	7,700
75	9,000	9,000	-	75	11,200	9,100	7,400
80	9,000	8,900	7,300	80	10,800	8,800	7,200
85	9,000	8,600	7,200	85	10,300	8,400	7,000
90	9,000	8,400	7,000	90	9,800	8,100	6,800
95	9,000	8,200	6,800	95	9,400	7,800	6,700
100	9,000	8,000	6,700	100	9,000	7,600	6,500
105	9,000	7,800	6,500	105	8,600	7,300	6,400
110	9,000	7,600	6,400	110	8,200	7,100	6,200
115	8,700	7,400	6,300	115	7,900	6,900	6,100
120	8,500	7,200	6,200	120	7,600	6,700	6,000
125	8,200	7,100	6,100	125	7,400	6,500	6,000
130	7,500	6,900	6,000	130	7,100	6,400	5,900
135	6,800	6,700	5,800	135	6,900	6,200	-
140	6,200	6,600	5,800	140	6,700	6,100	-
145	5,600	6,200	5,700	145	6,500	6,000	-
150	5,100	5,600	5,600	150	6,200	6,000	-
155	4,500	5,100	5,500	155	5,700	-	-
160	4,000	4,600	5,000	160	-	-	-
165	3,600	4,100	4,500	165	-	-	-
170	3,100	3,600	3,900	170	-	-	-
175	2,700	3,100	3,400	175	-	-	-
180	2,400	2,700	-	180	-	-	-
185	2,000	2,300	-	185	-	-	-
190	1,700	1,900	-	190	-	-	-
195	1,300	1,600	-	195	-	-	-

# Operation

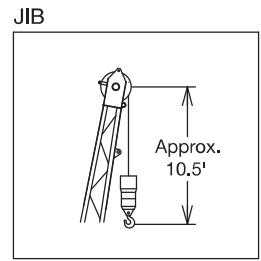
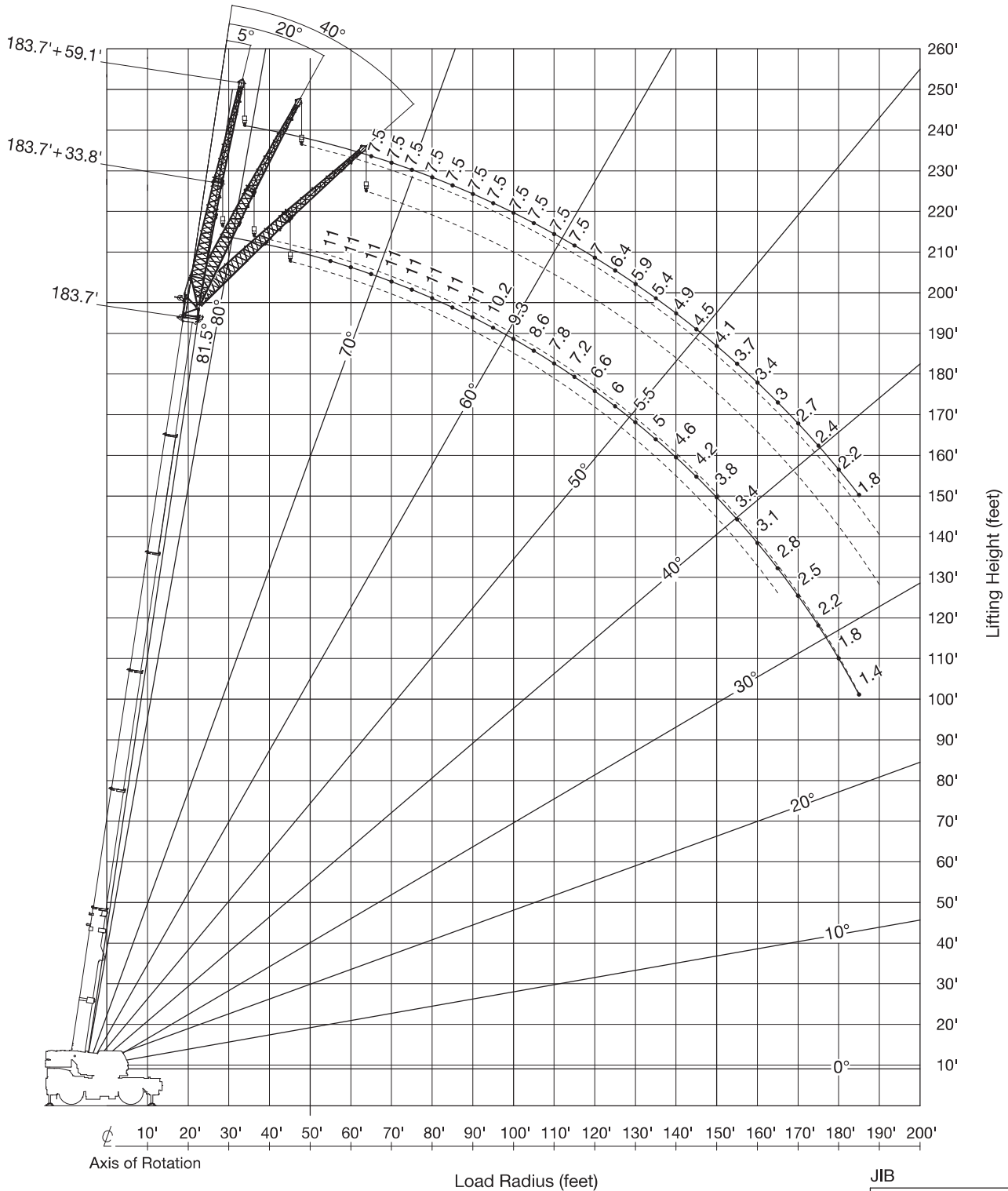

**NOTE:**

Jib geometry shown are for unloaded condition and machine standing level on firm supporting surface. Boom deflection and subsequent radius and boom angle change must be accounted for when applying load to hook.

# Operation

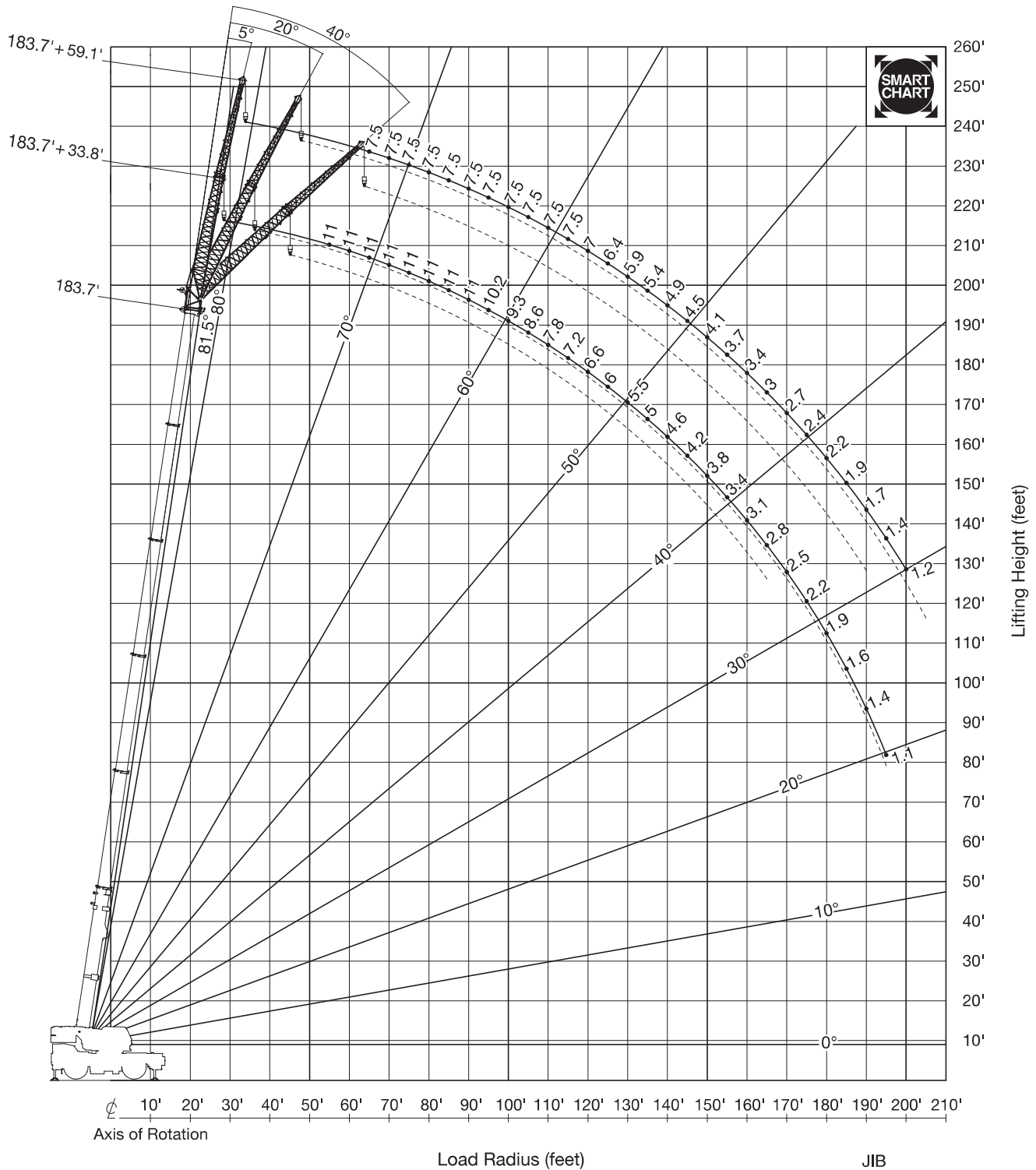

**NOTE:**

Jib geometry shown are for unloaded condition and machine standing level on firm supporting surface. Boom deflection and subsequent radius and boom angle change must be accounted for when applying load to hook.

# Operation

## Fully extended – 360° – Smart Chart

43,500 lb				360°			
25' 7" x 25' 5-1/2"				360°			
183.7' + 33.8'				172.9' + 33.8'			
ft	5°	20°	40°	ft	5°	20°	40°
1,000 lb				1,000 lb			
50	-	-	-	50	12,300	-	-
55	11,000	11,000	-	55	12,300	12,300	-
60	11,000	11,000	-	60	12,300	12,300	-
65	11,000	11,000	11,000	65	12,300	12,300	12,300
70	11,000	11,000	11,000	70	12,300	12,300	12,300
75	11,000	11,000	11,000	75	12,300	12,300	12,300
80	11,000	11,000	11,000	80	12,300	12,300	12,100
85	11,000	11,000	11,000	85	12,300	12,200	11,700
90	11,000	11,000	10,800	90	12,300	11,700	11,200
95	10,200	10,600	10,400	95	11,900	11,300	10,900
100	9,300	9,700	10,100	100	11,500	10,900	10,500
105	8,600	8,900	9,300	105	11,100	10,500	10,100
110	7,800	8,200	8,600	110	10,400	10,200	9,800
115	7,200	7,500	7,900	115	9,400	9,800	9,500
120	6,600	6,900	7,200	120	8,600	9,000	9,200
125	6,000	6,400	6,700	125	7,800	8,200	8,600
130	5,500	5,800	6,100	130	7,100	7,500	7,900
135	5,000	5,400	5,600	135	6,400	6,800	7,100
140	4,600	4,900	5,100	140	5,800	6,100	6,500
145	4,200	4,500	4,700	145	5,200	5,500	5,800
150	3,800	4,100	4,300	150	4,700	5,000	5,200
155	3,400	3,700	3,900	155	4,200	4,500	4,700
160	3,100	3,300	3,500	160	3,700	4,000	4,200
165	2,800	3,000	3,100	165	3,300	3,500	-
170	2,500	2,600	-	170	2,900	3,100	-
175	2,200	2,400	-	175	2,500	2,700	-
180	1,900	2,100	-	180	2,200	2,300	-
185	1,600	1,800	-	185	1,900	2,000	-
190	1,400	1,500	-	190	1,500	-	-
195	1,100	1,300	-	195	1,300	-	-



Smart Chart

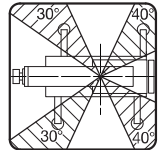

# Operation

## Fully extended – 360° – Smart Chart

43,500 lb				360°			
25' 7" x 25' 5-1/2"				360°			
159.6' + 33.8'				106.5' + 33.8'			
ft	5°	20°	40°	ft	5°	20°	40°
1,000 lb				1,000 lb			
25	-	-	-	25	29,500	-	-
30	-	-	-	30	29,500	24,000	-
35	-	-	-	35	28,800	22,400	-
40	-	-	-	40	27,500	21,100	15,900
45	14,800	-	-	45	26,300	19,900	15,300
50	14,800	14,800	-	50	24,900	18,800	14,800
55	14,800	14,800	-	55	23,200	17,900	14,300
60	14,800	14,800	14,500	60	21,700	17,000	13,800
65	14,800	14,800	14,100	65	20,400	16,300	13,400
70	14,800	14,800	13,700	70	19,300	15,600	13,100
75	14,800	14,800	13,400	75	18,300	15,000	12,700
80	14,800	14,700	13,100	80	17,400	14,500	12,400
85	14,700	14,100	12,800	85	16,600	14,000	12,100
90	14,000	13,600	12,500	90	15,600	13,500	11,900
95	13,300	13,100	12,200	95	14,200	13,100	11,700
100	12,200	12,500	12,000	100	12,900	12,700	11,500
105	11,100	11,700	11,800	105	11,800	12,200	11,400
110	10,000	10,600	11,100	110	10,700	11,100	-
115	9,100	9,600	10,100	115	9,800	10,100	-
120	8,200	8,700	9,100	120	9,000	9,200	-
125	7,400	7,900	8,300	125	8,200	8,400	-
130	6,700	7,100	7,500	130	7,500	-	-
135	6,100	6,400	6,700	135	-	-	-
140	5,400	5,800	6,100	140	-	-	-
145	4,900	5,200	5,400	145	-	-	-
150	4,400	4,600	4,800	150	-	-	-
155	3,900	4,100	-	155	-	-	-
160	3,400	3,600	-	160	-	-	-
165	3,000	3,200	-	165	-	-	-
170	2,600	2,700	-	170	-	-	-
175	2,200	2,300	-	175	-	-	-
180	1,900	-	-	180	-	-	-
185	1,600	-	-	185	-	-	-



Smart Chart

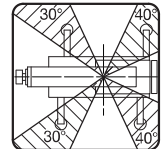

# Operation

## Fully extended – 360° – Smart Chart

43,500 lb				360°			
25' 7" x 25' 5-1/2"				360°			
183.7' + 59.1'				172.9' + 59.1'			
ft	5°	20°	40°	ft	5°	20°	40°
1,000 lb				1,000 lb			
55	-	-	-	55	7,900	-	-
60	7,500	-	-	60	7,900	-	-
65	7,500	-	-	65	7,900	-	-
70	7,500	-	-	70	7,900	7,900	-
75	7,500	7,500	-	75	7,900	7,900	-
80	7,500	7,500	-	80	7,900	7,900	-
85	7,500	7,500	-	85	7,900	7,900	7,100
90	7,500	7,500	6,800	90	7,900	7,900	6,900
95	7,500	7,500	6,700	95	7,900	7,900	6,800
100	7,500	7,500	6,600	100	7,900	7,700	6,700
105	7,500	7,400	6,500	105	7,900	7,600	6,500
110	7,500	7,300	6,300	110	7,900	7,400	6,400
115	7,500	7,100	6,200	115	7,900	7,200	6,300
120	7,000	7,000	6,200	120	7,900	7,100	6,200
125	6,400	6,800	6,000	125	7,700	6,900	6,000
130	5,900	6,500	5,900	130	7,400	6,800	5,900
135	5,400	6,000	5,800	135	7,000	6,600	5,800
140	4,900	5,500	5,700	140	6,400	6,500	5,700
145	4,500	5,000	5,500	145	5,800	6,400	5,600
150	4,100	4,600	5,000	150	5,300	5,900	5,600
155	3,700	4,200	4,600	155	4,800	5,300	5,500
160	3,400	3,800	4,200	160	4,300	4,800	5,300
165	3,000	3,500	3,800	165	3,900	4,400	4,800
170	2,700	3,100	3,500	170	3,500	3,900	4,300
175	2,400	2,800	3,100	175	3,100	3,500	3,800
180	2,200	2,500	2,800	180	2,800	3,100	3,400
185	1,900	2,200	2,500	185	2,400	2,700	3,000
190	1,700	2,000	2,200	190	2,100	2,400	-
195	1,400	1,700	-	195	1,800	2,100	-
200	1,200	1,400	-	200	1,500	1,700	-
205	-	1,200	-	205	1,200	1,400	-



Smart Chart

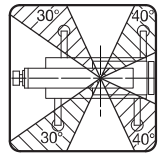



# Operation

## Fully extended – 360° – Smart Chart

43,500 lb				360°			
25' 7" x 25' 5-1/2"				360°			
159.6' + 59.1'				106.5' + 59.1'			
ft	5°	20°	40°	ft	5°	20°	40°
1,000 lb				1,000 lb			
30	-	-	-	30	12,600	-	-
35	-	-	-	35	12,600	-	-
40	-	-	-	40	12,600	-	-
45	-	-	-	45	12,600	11,900	-
50	9,000	-	-	50	12,600	11,400	-
55	9,000	-	-	55	12,600	11,000	-
60	9,000	-	-	60	12,600	10,500	8,200
65	9,000	9,000	-	65	12,200	10,000	7,900
70	9,000	9,000	-	70	11,700	9,500	7,700
75	9,000	9,000	-	75	11,200	9,100	7,400
80	9,000	8,900	7,300	80	10,800	8,800	7,200
85	9,000	8,600	7,200	85	10,300	8,400	7,000
90	9,000	8,400	7,000	90	9,800	8,100	6,800
95	9,000	8,200	6,800	95	9,400	7,800	6,700
100	9,000	8,000	6,700	100	9,000	7,600	6,500
105	9,000	7,800	6,500	105	8,600	7,300	6,400
110	9,000	7,600	6,400	110	8,200	7,100	6,200
115	8,700	7,400	6,300	115	7,900	6,900	6,100
120	8,500	7,200	6,200	120	7,600	6,700	6,000
125	8,200	7,100	6,100	125	7,400	6,500	6,000
130	7,500	6,900	6,000	130	7,100	6,400	5,900
135	6,800	6,700	5,800	135	6,900	6,200	-
140	6,200	6,600	5,800	140	6,700	6,100	-
145	5,600	6,200	5,700	145	6,500	6,000	-
150	5,100	5,600	5,600	150	6,200	6,000	-
155	4,600	5,100	5,500	155	5,700	-	-
160	4,100	4,600	5,000	160	-	-	-
165	3,700	4,100	4,500	165	-	-	-
170	3,300	3,700	4,000	170	-	-	-
175	2,900	3,200	3,500	175	-	-	-
180	2,500	2,800	-	180	-	-	-
185	2,200	2,500	-	185	-	-	-
190	1,900	2,100	-	190	-	-	-
195	1,600	1,800	-	195	-	-	-
200	1,300	1,400	-	200	-	-	-
205	1,000	-	-	205	-	-	-



Smart Chart

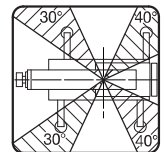

# Notes to Lifting Capacity

## GENERAL

1. RATED LIFTING CAPACITIES apply only to the machine as originally manufactured and normally equipped by TADANO LTD. Modifications to the machine or use of optional equipment other than that specified can result in a reduction of capacity.
2. Hydraulic cranes can be hazardous if improperly operated or maintained. Operation and maintenance of this machine must be in compliance with information, in the operation and maintenance manual supported with the crane. If this manual is missing, order a replacement through the distributor.
3. The operator and other personnel associated with this machine shall fully acquaint themselves with the latest American National Standards Institute (ANSI) safety standards for cranes.

## SET UP

1. Rated lifting capacities on the chart are the maximum allowable crane capacities and are based on the machine standing level on firm supporting surface under ideal job conditions. Depending on the nature of the supporting surface, it may be necessary to have structural supports under the outrigger floats or tires to spread the loads to a larger bearing surface.
2. For outrigger operation, outriggers shall be properly extended with tires free of supporting surface before operating crane.

## OPERATION

1. Rated lifting capacities have been tested to and meet minimum requirements of SAE J1063 - cantilevered Boom Crane Structures Method of Test.
2. Rated lifting capacities do not exceed 85% of the tipping load on outriggers fully extended as determined by SAE J765 - Crane Stability Test Code. Rated lifting capacities for partially extended outriggers are determined from the formula, rated lifting capacities = (tipping load - 0.1 x tip reaction) / 1.25.
3. Rated lifting capacities are based on actual load radius increased by boom deflection.
4. The weight of handling device such as hook blocks, slings, etc., must be considered as part of the load and must be deducted from the lifting capacities.
5. Rated lifting capacities are based on freely suspended loads and make no allowance for such factors as the effect of wind, sudden stopping of loads, supporting surface conditions, inflation of tires, operating speeds, side loads, etc. Side pull on boom or jib is extremely dangerous. Such action can damage the boom, jib or slewing mechanism, and lead to overturning of the crane.
6. Rated lifting capacities do not account for wind on lifted load or boom. We recommend against working under the condition that the load is out of control due to a strong wind. During boom lift, consider that the rated lifting capacity is reduced by 50% when the wind speed is 20 mph to 27 mph; reduced by 70% when the wind speed is 27 mph to 31 mph. If the wind speed is 31 mph or over, stop operation. During jib lift, stop operation if the wind speed is 20 mph or over.
7. Rated lifting capacities at load radius shall not be exceeded. Do not tip the crane to determine allowable loads.
8. Do not operate at boom lengths, radii, or boom angle, where no capacities are shown. Crane may overturn without any load on the hook.
9. When boom length is between values listed, refer to the rated lifting capacities of the next longer and next shorter booms for the same radius. The lesser of the two rated lifting capacities shall be used.
10. When making lifts at a load radius not shown, use the next longer radius to determine allowable capacity.
11. Load per line should not exceed 15,900 lb for main winch and auxiliary winch.
12. Check the actual number of parts of line with LOAD MOMENT INDICATOR (AML-E2) before operation. Maximum lifting capacity is restricted by the number of parts of line of LOAD MOMENT INDICATOR (AML-E2). Limited capacity is as determined from the formula, single line pull for main winch 15,900 lb x number of parts of line.
13. The boom angle before loading should be greater to account for deflection. For rated lifting capacities, the loaded boom angle and the load radius is for reference only. The 40.0' boom length capacities are based on boom fully retracted.
14. Maximum capacity without boom pin is shown in the chart.
15. Do not operate extension or retraction of the boom with loads. The ability to telescope loads is limited by hydraulic pressure, boom angle, boom length, crane maintenance, etc.
16. For lifting capacity of single top, deduct the weight of the load handling equipment from the rated lifting capacity of the boom. For the lifting capacity of single top, the net capacity shall not exceed 15,900 lb including the main boom hook mass attached to the boom.
17. When the base jib or top jib or both jibs are dismounted, set the jib state switch to the DISMOUNTED position.
18. When erecting and stowing jib, be sure to retain it by hand or by other means to prevent its free movement.
19. Use "ANTI-TWOBLOCK" disable switch when erecting and stowing jib and when stowing hook block. While the switch is pushed, the hoist does not stop, even when overwind condition occurs.
20. When lifting a load by using jib (aux. winch) and boom (main winch) simultaneously, do the following:
  - Enter the operation status as jib operation, not as boom operation.
  - Before starting operation, make sure that mass of load is within rated lifting capacity for jib.
21. Crane operation is prohibited without full counterweight 43,500 lb mounted. Outriggers shall be extended 25' 7" spread when mounting or dismounting removable counterweight.

## DEFINITIONS

1. Load radius: Horizontal distance from a projection of the axis of rotation to supporting surface before loading to the center of the vertical hoist line or tackle with load applied.
2. Loaded boom angle: The angle between the boom base section and the horizontal, after lifting the rated lifting capacity at the load radius.
3. Working area: Area measured in a circular arc about the centerline of rotation.
4. Freely suspended load: Load hanging free with no direct external force applied except by the hoist line.
5. Side load: Horizontal side force applied to the lifted load either on the ground or in the air.

# Warning and Operating Instructions

## Notes for on Rubber Lifting Capacities

1. Rated lifting capacities on-rubber are in pounds and do not exceed 75% of tipping loads as determined by SAE J765-Crane Stability Test Code.
2. Rated lifting capacities shown in the chart are based on condition that crane is set on firm level surfaces with suspension-lock applied. They are based on actual load radius increased by tire deformation and boom deflection.
3. If the suspension-lock cylinders contain air, the axle will not be locked completely and rated lifting capacities may not be obtainable. Bleed the cylinders according to the operation safety and maintenance manual.
4. Rated lifting capacities are based on proper tire inflation, capacity and condition. Damaged tires are hazardous to safe operation of crane.
5. Tires shall be inflated to correct air pressure. 29.5-25☆☆ – air pressure: 94 psi · 29.5-25 38PR – air pressure: 87 psi.
6. Over front operation shall be performed within 2° in front of chassis.
7. On-rubber lifting with “jib” is not permitted. Maximum permissible boom length is 93.2 ft.
8. When making lift on-rubber stationary, set parking brake.
9. For creep operation, boom must be centered over front of machine, slewing lock engaged, and load restrained from slewing. Travel slowly and keep the lifted load as close to the ground as possible, and especially avoid any abrupt steering, accelerating or braking.
10. Do not operate the crane while carrying the load.
11. Creep is motion for crane not to travel more than 200 ft in any 30 minute period and to travel at the speed of less than 1 mph.
12. For creep operation, choose the drive mode and proper gear according to the road or working condition.

## Notes for Load Moment Indicator (AML-E2)

1. Set AML select keys in accordance with the actually operating crane conditions and don't fail to make sure, before crane operation, that the displays on front panel are correct.
2. When operating crane on outriggers:
  - Set “P.T.O.” switch to “ON”.
  - Press the outrigger state select key to register for the outrigger operation. If the display agrees with the actual state, press the set key to register. After the completion of the registration, the display returns to the crane operation status.
  - Press the lift state select key to register the lift state to be used (single top/jib/boom).
  - Each time the lift state select key is pressed, the display changes. If the display agrees with the actual state, press the set key to register. After the completion of the registration, the display returns to the crane operation status.
  - When erecting and stowing jib, select the status of jib set (jib state indicative symbol lights up).
3. When operating crane on-rubber:
  - Set “P.T.O.” switch to “ON”.
  - Press the outrigger state select key to register for the on-rubber operation. Each time the outrigger state select key is pressed, the display changes. Select the creep operation, the on-rubber state indicator symbol lights up.
  - Press the lift state select key to register the lift state.However, pay attention to the following.
  - (1) For stationary operation.
    - The front capacities are attainable only when the over front position symbol comes on. When the boom is more than 2° from centered over front of chassis, 360° capacities are in effect.
    - When a load is lifted in the front position and then slewed to the side area, make sure the value of the LOAD MOMENT INDICATOR (AML-E2) is below the 360° lifting capacity.
  - (2) For creep operation.
    - The creep capacities are attainable only when boom is in the straight forward position of chassis and the over front position symbol is on. If boom is not in the straight forward position of chassis, never lift load.
4. This machine is equipped with an automatic slewing stopping device (for the details, see operation and maintenance manual). But, operate very carefully because the automatic slewing stop does not work in the following cases.
  - During on-rubber operation.
  - When the “P.T.O.” switch is set to “OVERRIDE” and the “OVERRIDE” key switch outside the cab is on.
5. During crane operation, make sure that the displays on front panel are in accordance with actual operating conditions.
6. The displayed values of LOAD MOMENT INDICATOR (AML-E2) are based on freely suspended loads and make no allowance for such factors as the effect of wind, sudden stopping of loads, supporting surface conditions, inflation of tire, operating speed, side loads, etc. For safe operation, it is recommended when extending and lowering boom or slewing, lifting loads shall be appropriately reduced.
7. LOAD MOMENT INDICATOR (AML-E2) is intended as an aid to the operator. Under no condition should it be relied upon to replace use of capacity charts and operating instruction. Sole reliance upon LOAD MOMENT INDICATOR (AML-E2) aids in place of good operating practice can cause an accident. The operator must exercise caution to assure safety.
8. The lifting capacity differs depending on the outrigger extension width and slewing position. Work with the capacity corresponding to the outrigger extension width and slewing position. For the relationship among the outrigger extension width, slewing position and lifting capacities, refer to the working area charts.



# TECHNICAL DESCRIPTION

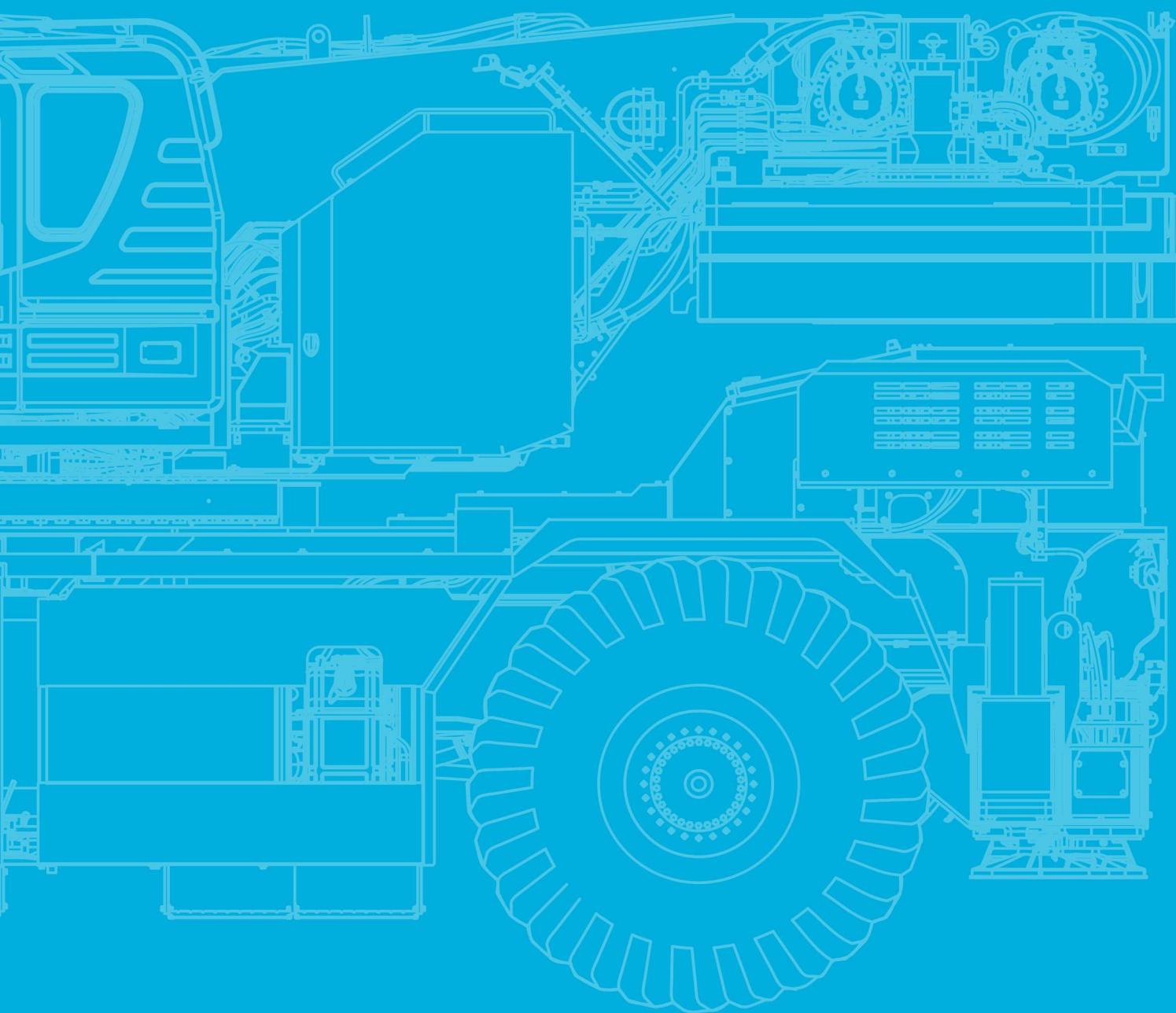



# Technical Description

## Crane specifications

<b>Boom</b>	6 section boom, single cylinder telescoping with pinning system, 40.0' - 183.7', of round box construction with 7 sheaves, 15-3/4" root diameter, at boom head. 2 easily removable wire rope guards, rope dead end provided on both sides of boom head. Boom telescope sections are supported by wear pads both vertically and horizontally. Extension speed 143.7' in 410 seconds.
<b>Boom elevation</b>	By a double acting hydraulic cylinder with holding valve. Elevation -1.5° - 81.5°, combination controls for hand or foot operation. Boom angle indicator. Automatic speed reduction and slow stop function. Boom raising speed 20° to 60° in 28 seconds.
<b>Jib</b>	2 stage bi-fold lattice jib with 5°-40° hydraulic offset. Single sheave, 17-5/16" root diameter, at the head of both jib sections. Stored alongside base boom section. Jib length is 33.8' or 59.1'. Assistant cylinders for mounting and stowing, controlled at right side of superstructure. Self stowing jib mounting pins.
<b>Auxiliary lifting sheave (single top)</b>	Single sheave, 17-5/16" root diameter. Mounted to main boom head for single line work (storable).
<b>Anti-two block</b>	Pendant type over-winding cut out device with audio-visual (FAILURE lamp/BUZZER) warning system.
<b>Slewing</b>	Hydraulic axial piston motor through planetary slewing speed reducer. Continuous 360° full circle slewing on ball bearing turn table at 1.3 min <sup>-1</sup> {rpm}. Equipped with manually locked/released slewing brake. A 360° positive slewing lock for pick and carry and travel modes, manually engaged in cab. Twin slewing system: Free slewing or lock slewing controlled by selector switch on front console.
<b>Winch</b>	<p><b>MAIN WINCH:</b> Variable speed type with grooved drum driven by hydraulic axial piston motor through speed reducer. Power load lowering and raising. Equipped with automatic brake (neutral brake) and counterbalance valve. Controlled independently of auxiliary winch. Equipped with cable follower and drum rotation indicator.</p> <p><b>DRUM:</b> Grooved 15" root diameter x 29-1/4" wide. Wire rope: 1050' of 3/4" diameter rope. Drum capacity: 1293' 7 layers. Maximum single line pull: 1st layer 21,800 lb. Maximum permissible line pull wire strength: 15,900 lb.</p> <p><b>AUXILIARY WINCH:</b> Variable speed type with grooved drum driven by hydraulic axial piston motor through speed reducer. Power load lowering and raising. Equipped with automatic brake (neutral brake) and counterbalance valve. Controlled independently of main winch. Equipped with cable follower and drum rotation indicator.</p> <p><b>DRUM:</b> Grooved 15" root diameter x 29-1/4" wide. Wire rope: 738' of 3/4" diameter rope. Drum capacity: 1293' 7 layers. Maximum single line pull: 1st layer 21,800 lb. Maximum permissible line pull wire strength: 15,900 lb.</p> <p><b>WIRE ROPE:</b> Non-rotating 3/4" - 7 x 35 class. Breaking strength 79,400 lb.</p>
<b>Hook blocks</b>	100 ton - 7 sheaves with swivel hook block and safety latch. 7.9 ton - Weighted hook with swivel and safety latch.
<b>Counterweight</b>	Self-removable counterweight: 43,500 lb.
<b>Hydraulic system</b>	<p><b>PUMPS:</b> 2 variable piston pumps for crane functions. Tandem gear pump for steering, slewing and other hydraulic systems. Powered by carrier engine. Pump disconnect for crane is engaged/ disengaged by rotary switch from operator's cab.</p> <p><b>CONTROL VALVES:</b> Multiple valves actuated by pilot pressure with integral pressure relief valves.</p> <p><b>RESERVOIR:</b> 210 gallons capacity. External sight level gauge.</p> <p><b>FILTRATION:</b> BETA10 = 10 return filter, full flow with bypass protection, located inside of hydraulic reservoir. Accessible for easy replacement.</p> <p><b>OIL COOLER:</b> Air cooled fan type.</p>
<b>Cab and controls</b>	Both crane and drive operations can be performed from one cab mounted on rotating superstructure. 20° tilt, left side, 1 man type, steel construction with sliding door access and safety glass windows opening at side. Door window is powered control. Windshield glass window and roof glass window are shatter-resistant. Tilt-telescoping steering wheel. Adjustable control lever stands for slewing, boom elevating, boom telescoping, auxiliary winch and main winch. Control lever stands can change neutral positions and tilt for easy access to cab. 3 way adjustable operator's seat with high back, headrest and armrest. Engine throttle knob. Foot operated controls: boom elevating boom telescoping, service brake and engine throttle. Hot water cab heater and air conditioning. Dash-mounted instrument panel, multi function display, starter switch (engine start/stop), 12 V power outlet, USB port, drive selector switch, parking brake switch, steering mode select switch, power window switch, pump engaged/ disengaged switch, slewing brake switch, telescoping/auxiliary winch select switch, outrigger controls, free slewing/ lock slewing selector switch, air conditioning control switch. Instruments panel: Torque converter oil temperature, engine water temperature, air pressure, fuel, speedometer, tachometer, hour meter and odometer/tripmeter. Multi function display: DEF level gauge, fuel consumption monitor.

# Technical Description

## Crane specifications

Tadano electronic LOAD MOMENT INDICATOR system (AML-E2) including:  
 Control lever lockout function with audible and visual pre-warning. Number of parts of line. Boom position indicator. Outrigger state indicator. Slewing angle. Boom angle / boom length / jib offset angle / jib length / load radius / rated lifting capacities / actual loads read out. Potential lifting height. Ratio of actual load moment to rated load moment indication. Automatic speed reduction and slow stop function on boom elevation and slewing. Working condition register switch. Load radius / boom angle / tip height / slewing range preset function. External warning lamp. Tare function. Main hydraulic oil pressure. Fuel consumption monitor. Main winch / auxiliary winch select. Drum rotation indicator (audible and visible type) main and auxiliary winch. On rubber indicator.

TADANO AML-E2 monitors outrigger extended length and automatically programs the corresponding "RATED LIFTING CAPACITIES" table.

Operator's right hand console includes transmission gear selector, slewing lock lever and sight level bubble. Upper console includes, roof washer and wiper switch, emergency outrigger set up key switch, jib equipped / removed select switch, high speed winch (main /aux.) switch, cab tilt switch, pump disconnect enable switch and boom emergency.

*NOTE:* Each crane motion speed is based on unladen conditions.

## Carrier specifications

<b>Type</b>	Rear engine, left hand steering, driving axle 2-way selected type by manual switch, 4 x 2 front drive, 4 x 4 front and rear drive.
<b>Frame</b>	High tensile steel, all welded mono-box construction.
<b>Engine</b>	Model: Cummins B6.7 · Type: Direct injection diesel · No. of cylinders: 6 · Combustion: 4 cycle, turbo charged and after cooled · Bore x stroke: 4.212 in. x 4.882 in. · Displacement: 408 cu. in liters · Air inlet heater: 24 volt preheat · Air cleaner: Dry type, replaceable element · Oil filter: Full flow with replaceable element · Fuel filter: Full flow with replaceable element · Fuel tank: 79.2 gallons, right side of carrier · Cooling: Liquid pressurized, recirculating by-pass · Radiator: Fin and tube core, thermostat controlled · Fan: Suction type, 9-blade, 28 in. diameter · Starting: 24 volt · Charging: 24 volt system, negative ground · Battery: 2-120 amp. hour · Compressor, air: 17.0 cfm @ 2,400 rpm · Output, max.: Gross 280 HP (209 kW) @ 2,200 rpm · Torque, max.: 850 ft-lb (1,152 Nm) @ 1,500 rpm · Capacity: Cooling water 2.7 gallons, lubrication 4.0 gallons, fuel 79.2 gallons, DEF/AdBlue 15.0 gallons.
<b>Transmission</b>	Electronically controlled full automatic transmission. Torque converter driving full powershift with driving axle selector. 5 forward and 2 reverse speeds, constant mesh. 2 speeds - high range - 2 wheel drive; 4 wheel drive. 3 speeds - low range - 4 wheel drive.
<b>Travel speed</b>	12 mph.
<b>Gradeability</b>	57% (at stall), machine should be operated within the limit of engine crankcase design (30°: Cummins B6.7).
<b>Axle</b>	Front: Full floating type, steering and driving axle with planetary reduction. Rear: Full floating type, steering and driving axle with planetary reduction.
<b>Steering</b>	Hydraulic power steering controlled by steering wheel. Four steering modes available: 2 wheel front, 2 wheel rear, 4 wheel coordinated and 4 wheel crab.
<b>Suspension</b>	Front: Rigid mounted to frame. Rear: Pivot mounted with hydraulic lockout device.
<b>Brake systems</b>	Service: Air over hydraulic disc brakes on all 4 wheels. Parking / Emergency: Spring applied-air released brake acting on input shaft of front axle. Auxiliary: Electro-pneumatic operated exhaust brake.
<b>Tires</b>	29.5R25 ☆☆ (OR) - air pressure: 94 psi or 29.5-25 38PR (OR) - air pressure: 87 psi.
<b>Outriggers</b>	Four hydraulic, beam and jack outriggers. Vertical jack cylinders equipped with integral holding valve. Each outrigger beam and jack is controlled independently from cab. Beams extend to 25' 7" center-line and retract to within 10' 10-1/2" overall width with floats. Outrigger jack floats are attached thus eliminating the need of manually attaching and detaching them. Controls and sight bubble located in superstructure cab. Four outrigger extension lengths are provided with corresponding "RATED LIFTING CAPACITIES" for crane duty in confined areas. Min. extension: 9' 6-3/16" center to center Mid. extension: 18' 1/2" center to center Mid. extension: 23' 11-3/8" center to center Max. extension: 25' 7" center to center Float size (diameter): 1' 10- 1/2"

# Technical Description

## Standard equipment

<b>6 section extended boom by single telescoping cylinder</b>	40.0'-183.7'.
<b>Bi-fold lattice jib</b>	33.8' or 59.1' – offset angle (5°- 40°) by tilt cylinder.
<b>Quick reeving type bi-fold jib</b>	
<b>Anti-two block device</b>	Overwind cutout.
<b>Winch drum camera with light</b>	
<b>LED work lights</b>	
<b>Variable speed main winch</b>	With grooved drum, cable follower, drum rotation indicator (audible, visible and thumper type) and 1050' of 3/4" cable.
<b>Variable speed auxiliary winch</b>	With grooved drum, cable follower, drum rotation indicator (audible, visible and thumper type) and 738' of 3/4" cable.
<b>Auxiliary lifting sheave</b>	Single top, stowable.
<b>2-speed winch</b>	
<b>Hook block</b>	100 ton, 7 sheaves with swivel hook and safety latch for 3/4" wire rope.
<b>Hook</b>	7.9 ton hook with swivel.
<b>Tadano twin slewing system and 360° positive slewing lock</b>	
<b>Positive control</b>	
<b>Hydraulic oil cooler</b>	
<b>3 way adjustable cloth seat</b>	With armrests, high back and seat belt.
<b>Tilt-telescoping steering wheel</b>	
<b>Tinted safety glass and sun visor</b>	
<b>Front windshield wiper and washer</b>	
<b>Roof window wiper and washer</b>	
<b>Power window</b>	Cab door.
<b>12 V power outlet</b>	
<b>Ashtray</b>	
<b>Cab floor mat</b>	
<b>Pump disconnect in operator's cab</b>	
<b>Air conditioner</b>	Hot water heater and cooler.
<b>Full instrumentation package</b>	
<b>Self centering finger control levers</b>	With pilot control.
<b>Control pedals</b>	For boom elevating and boom telescoping.
<b>Warning device (visual)</b>	Low oil pressure / high water temperature.
<b>Air cleaner dust indicator</b>	
<b>Cup holder</b>	
<b>Battery disconnect</b>	
<b>USB port</b>	
<b>20° tilt cab</b>	
<b>Emergency steering system</b>	
<b>Tadano electronic load moment indicator system (AML-E2)</b>	
<b>Boom angle indicator</b>	
<b>Outrigger extension length detector</b>	



# Technical Description

## Standard equipment

Electronic crane monitoring system

Rear view camera

Right front view camera

Fenders

Air dryer

Complete highway light package

Towing hooks Front and rear.

Hook block tie down Front bumper.

Weighted hook storage compartment

Halogen head lamp

Independently controlled outriggers

Four outrigger extension positions

Self-storing outrigger pads

Electronic controlled automatic transmission driven by torque converter

Drive / steer 4 x 4 x 4.

Automatic rear axle oscillation lockout system

Tires 29.5R25 ☆☆.  
29.5-25 38PR.

Disc brakes

Water separator with filter High filtration.

Back-up alarm

24 volt electric system

Tool storage compartment

Tire inflation kit

Engine Cummins B6.7 turbo charged after cooled engine (280 HP) with exhaust brake.

Engine over-run alarm

Lifting eyes

Telematics Machine data logging and monitoring system with HELLO-NET via internet (availability depends on countries).

Fuel consumption monitor

Eco mode system

Self-removable counterweight

Radiator cover

Clearance sonar Rear side.

Automatic pump disconnect

Over unwinding prevention

Boom and jib mounted aircraft warning light

Wind speed indicator

## Optional equipment

Fall protection system on boom

**Notes**

A series of horizontal lines provided for taking notes.



[tac.sales@tadano.com](mailto:tac.sales@tadano.com)  
[www.tadanoamericas.com](http://www.tadanoamericas.com)

**Tadano PanAmerican Operations**  
4242 W Greens Road, Houston, TX 77066  
Phone: +1 (281) 869-0030



Lifting your dreams

